

TECHNICAL SPECIFICATION / TECHNISCHE BESCHREIBUNG / DESCRIPTION TECHNIQUE

DESK / SCHREIBTISCH / BUREAU

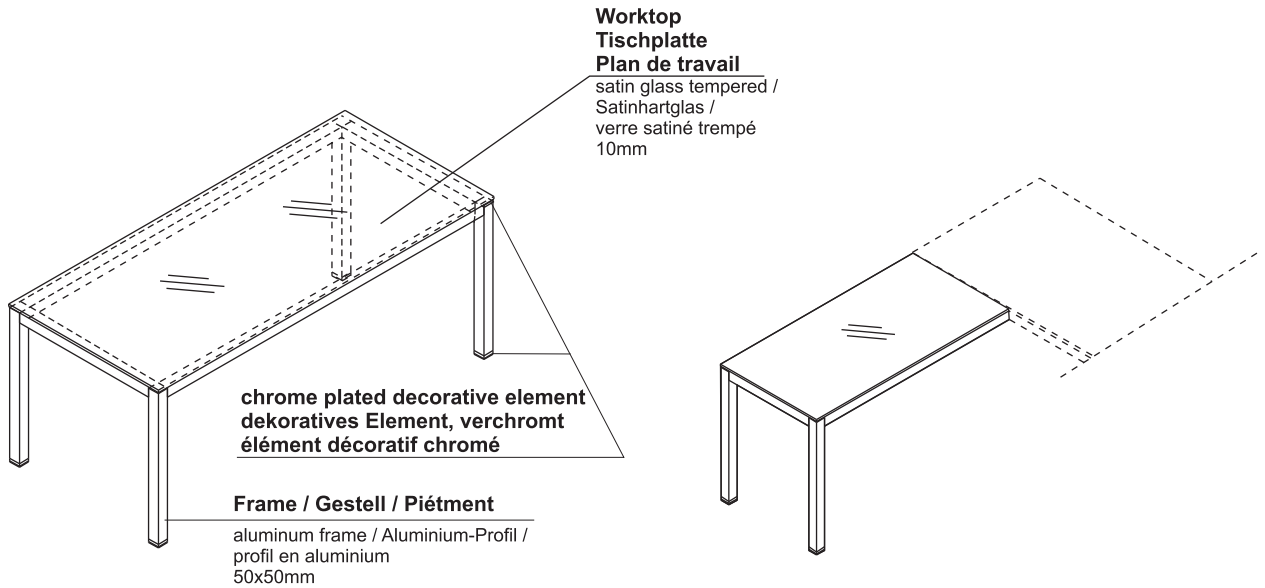

DESK / SCHREIBTISCH / BUREAU

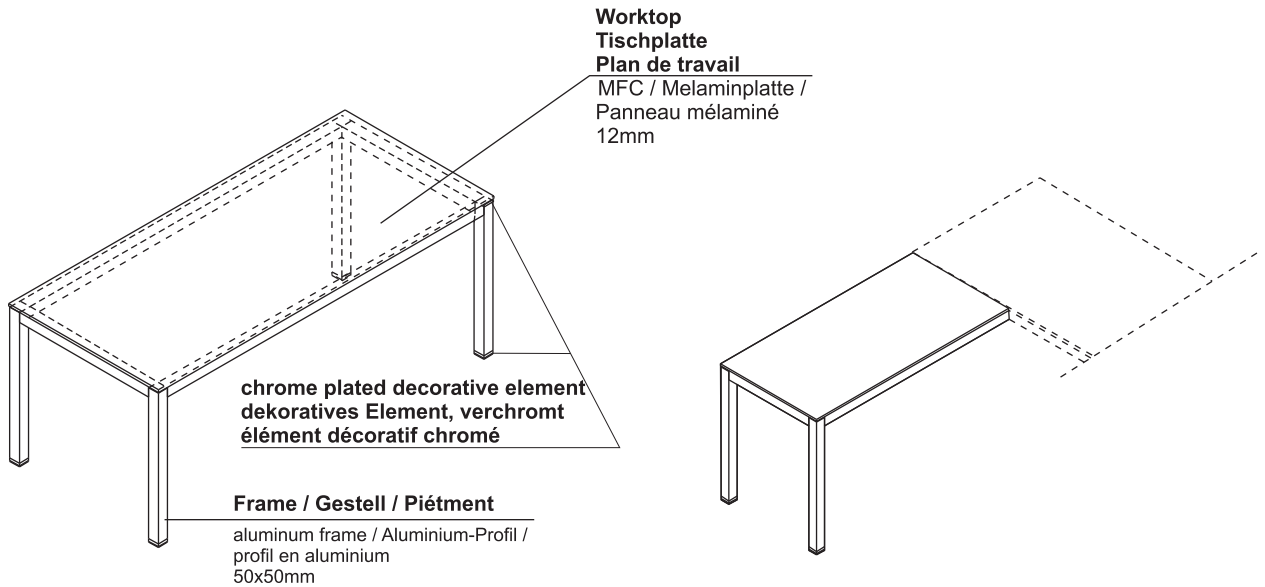

EXTENSION, MODESTY PANEL / ANSATZTISCH, KNEIBLENDE / EXTENSION, VOILE DE FOND

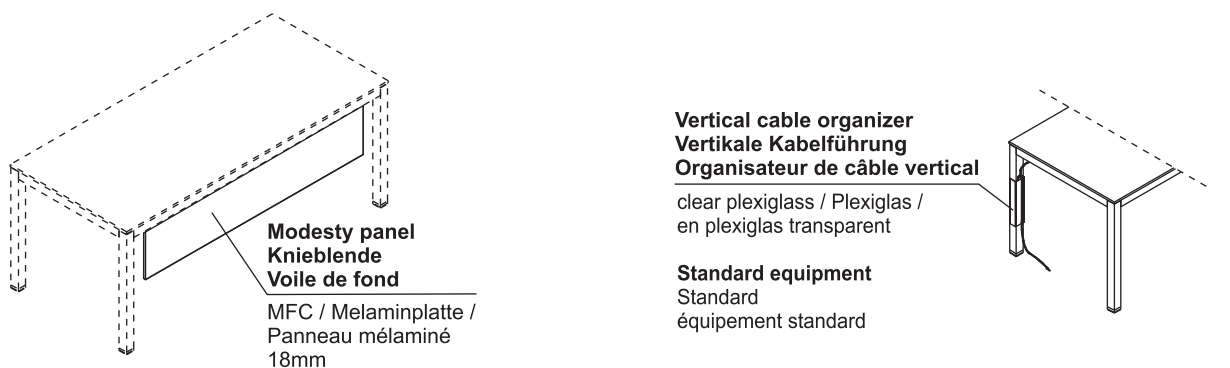

CONFERENCE TABLE / KONFERENZTISCH / TABLES DE REUNION

Top
Tischplatte
Plateau

MFC / Melaminplatte /
Panneau mélaminé
12mm

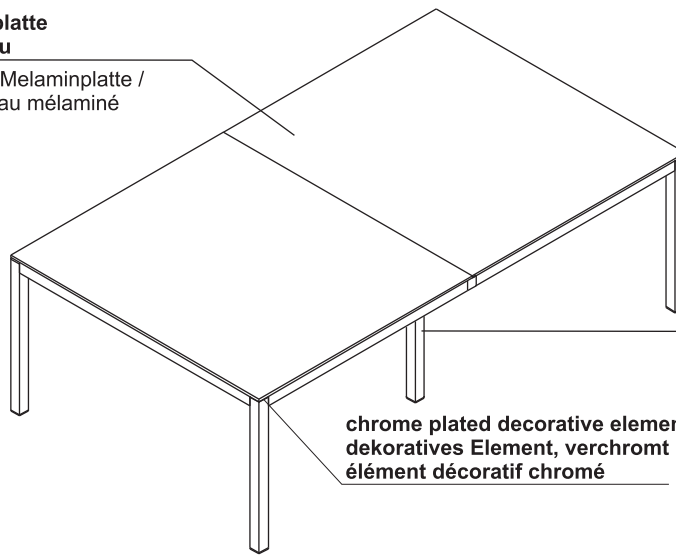

Frame / Gestell / Piétement

aluminum frame / Aluminium-Profil /
profil en aluminium
50x50mm

chrome plated decorative element
dekoratives Element, verchromt
élément décoratif chromé

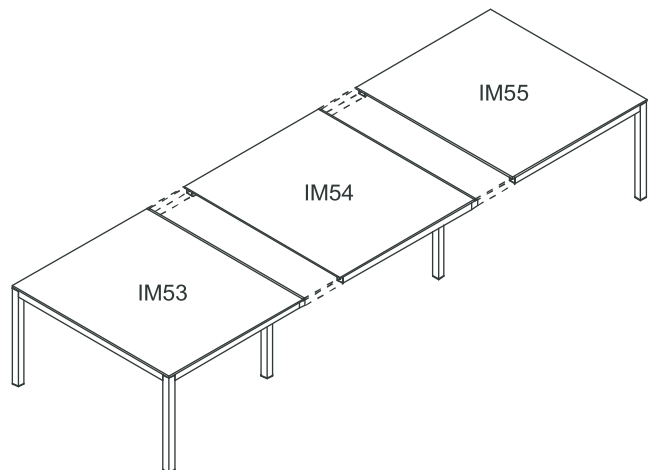
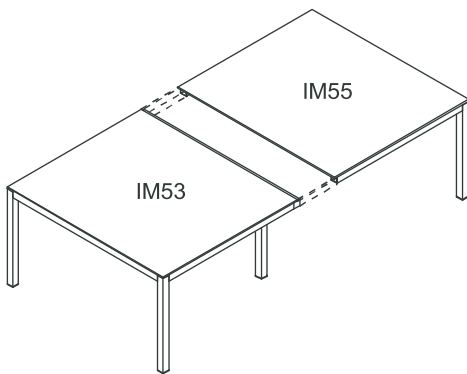

MEDIABOX M04

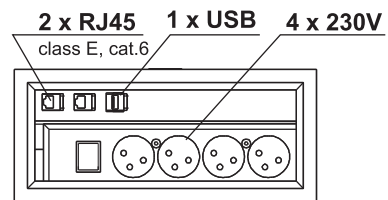
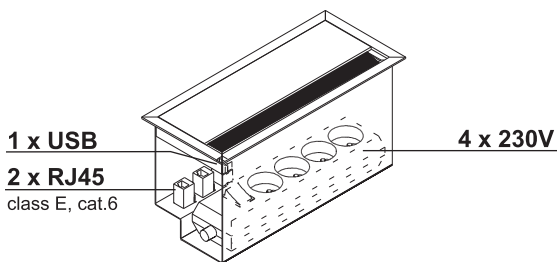

MEDIABOX M04 / MEDIABOX M04 / CONFIGURATION DE MEDIABOX M04



- Mediabox only for MFC worktop / Mediabox nur bei Melaminplatte möglich / Mediabox seulement pour les plateaux en mélamine
- possibility to install in a single position (M) selected when ordering / Mediabox in der Mitte (M) platziert / possibilité de placer le mediabox dans l'endroit (M) indiqué

MEDIABOX M04 CONFIGURATION - MODULAR TABLES / MEDIABOX M04 - FÜR MODUL SCHREIBTISCHE / CONFIGURATION DE MEDIABOX M04 - TABLES MODULAIRES



- Mediabox only for MFC worktop / Mediabox nur bei Melaminplatte möglich / Mediabox seulement pour les plateaux en mélamine
- possibility to install in a single position (M) selected when ordering / Mediabox in der Mitte (M) platziert / possibilité de placer le mediabox dans l'endroit (M) indiqué

STORAGE / SCHRÄNKE / RANGEMENTS

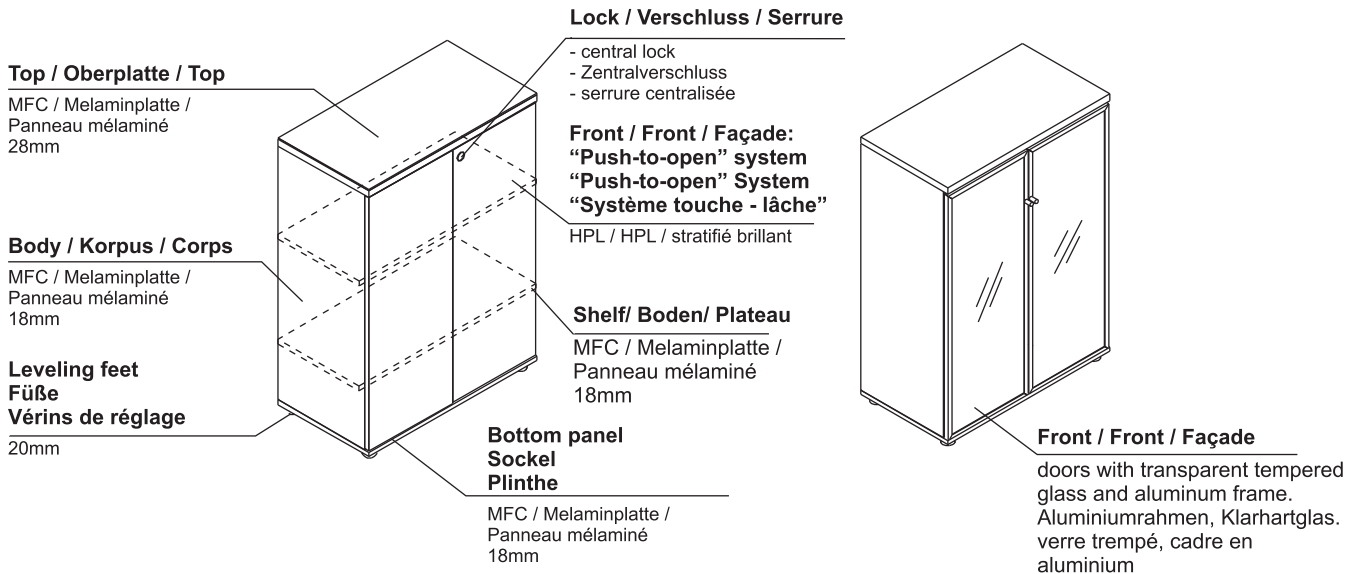

MANAGER STORAGE WITH GLASS / SIDEBORD MIT GLAS / RANGEMENTS

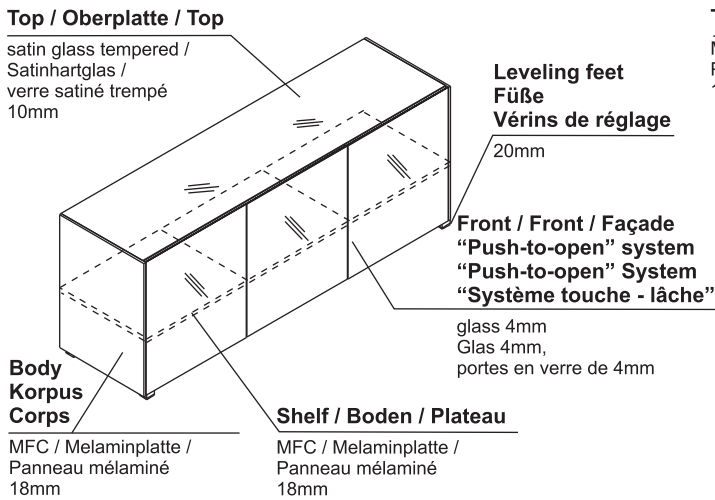

MANAGER STORAGE / SIDEBORD / DESSERTTE DE MANAGER

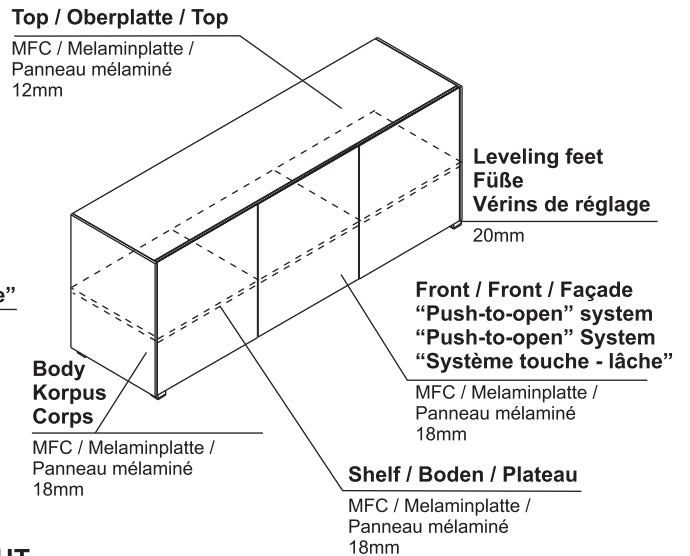

PEDESTAL / CONTAINER / CAISSON SLD13HT / SLD12HT

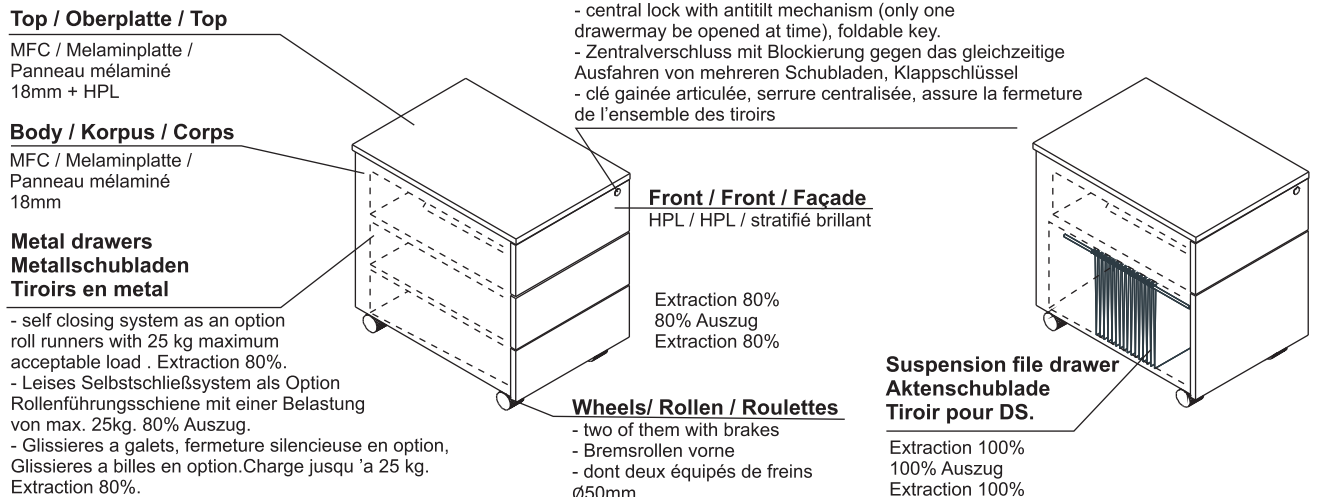

FINISHES / FARBEN / FINITIONS



117-WHITE GLASS GLAS WEIß VERRE BLANC	116-BLACK GLASS GLAS SCHWARZ VERRE NOIR			
08-BLACK SCHWARZ NOIR	31-CANADIAN OAK KANADISCHE EICHE CHENE CANADIEN	34-CHESTNUT WENGE WENGE	67-WHITE PASTEL WEIß PASTELL BLANC PASTEL	
15-HIGH GLOSS WHITE WEIß GLANZ BLANC BRILLANT	08-BLACK SCHWARZ NOIR			

CONFERENCE TABLE / KONFERENZTISCH / TABLES DE REUNION

08-BLACK SCHWARZ NOIR	31-CANADIAN OAK KANADISCHE EICHE CHENE CANADIEN	34-CHESTNUT WENGE WENGE	67-WHITE PASTEL WEIß PASTELL BLANC PASTEL	
15-HIGH GLOSS WHITE WEIß GLANZ BLANC BRILLANT	08-BLACK SCHWARZ NOIR			

STORAGE, PEDESTAL / SCHRÄNKE, CONTAINER / RANGEMENTS, CAISSON

67-WHITE WEIß BLANC	08-BLACK SCHWARZ NOIR		Front - doors with transparent tempered glass and aluminum frame - Aluminiumrahmen, Klarhartglastür - verre trempé, cadre en aluminium				
73-HIGH GLOSS WHITE WEIß GLANZ BLANC BRILLANT	74-HIGH GLOSS ORANGE ORANGE GLANZ ORANGE BRILLANT	80-HIGH GLOSS LIME GRÜN GLANZ VERT BRILLANT	81-HIGH GLOSS BURGUNDY DUNKELROT GLANZ BORDEAUX BRILLANT	101-HIGH GLOSS BLACK SCHWARZ GLANZ NOIR BRILLANT			Front - doors with transparent tempered glass and aluminum frame - Aluminiumrahmen, Klarhartglastür - verre trempé, cadre en aluminium
08-BLACK SCHWARZ NOIR	31-CANADIAN OAK KANADISCHE EICHE CHENE CANADIEN	34-CHESTNUT WENGE WENGE	67-WHITE PASTEL WEIß PASTELL BLANC PASTEL				
08-BLACK SCHWARZ NOIR	116-BLACK GLASS SCHWARZ GLAS NOIR VERRE						
67-WHITE WEIß BLANC	117-WHITE GLASS WEIß GLAS BLANC VERRE						
08-BLACK SCHWARZ NOIR	101-HIGH GLOSS BLACK SCHWARZ GLANZ NOIR BRILLANT						
67-WHITE WEIß BLANC	73-HIGH GLOSS WHITE WEIß GLANZ BLANC BRILLANT						

PRODUCT ILLUSTRATION / PRODUKTANSICHT UND SKIZZE / VUE DE PRODUIT	DIMENSIONS / ABMESSUNGEN [mm]			INDEX SYMBOL					ECO	COMMENTS / BEMERKUNGEN / REMARQUES
	WIDTH / BREITE / LARGEUR	DEPTH / TIEFE / PROFONDEUR	HEIGHT / HÖHE / HAUTEUR			kg	m3	pcs	EUR	

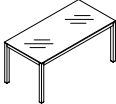
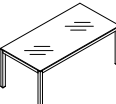
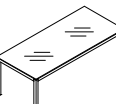

DESK - GLASS / SCHREIBTISCHE - GLASPLATTE / BUREAU - VERRE

	1600	800	760	IM04S		71.5	0.117	2	7.007	
	1800	900	760	IM05S		87.0	0.139	2	8.526	
	2000	900	760	IM06S		97.0	0.152	2	9.506	

EXTENSIONS - GLASS / ANSATZTISCH - GLASPLATTE / EXTENSIONS EN VERRE

	1200	600	760	IM07S		42.0	0.077	2	4.116	
---	------	-----	-----	--------------	--	------	-------	---	-------	--

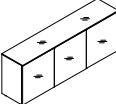
MANAGERIAL STORAGE WITH GLASS / KOMMODE MIT GLASPLATTE / RANGEMENT

	2000	432	740	IM20S		105.0	0.150	2	11.655	
	1334	432	740	IM21S		59.0	0.122	2	6.549	

DESK - GLASS / TISCH - GLASPLATTE / BUREAU - VERRE

	800	800	500	IM57S		39.0	0.068	2	3.822	
---	-----	-----	-----	--------------	--	------	-------	---	-------	--

DESCRIPTION / LEGENDE / LÉGENDE:

 net weight / Nettogewicht / poids net

 volume / Volumen / le volume

 number of packages / Stückzahl der Pakete / nombre de colis

PRODUCT ILLUSTRATION / PRODUKTANSICHT UND SKIZZE / VUE DE PRODUIT	DIMENSIONS / ABMESSUNGEN [mm]			INDEX SYMBOL					ECO	COMMENTS / BEMERKUNGEN / REMARQUES
	WIDTH / BREITE / LARGEUR	DEPTH / TIEFE / PROFONDEUR	HEIGHT / HÖHE / HAUTEUR			kg	m3	pcs	EUR	

MFC DESKS / SCHREIBTISCHE - MELAMINPLATTE / BUREAU - MÉLAMINÉ

	1600	800	760	IM04		21.5	0.079	2	2.107	
	1800	900	760	IM05		26.0	0.092	2	2.548	
	2000	900	760	IM06		28.0	0.100	2	2.744	

EXTENSION - MFC / ANSATZSTÜCK FÜR SCHREIBTISCH - MELAMINPLATTE / EXTENSIONS - MÉLAMINÉ

	1200	600	760	IM07		13.0	0.053	2	1.274	
--	------	-----	-----	-------------	--	------	-------	---	-------	--

MANAGERIAL STORAGE / SIDEBOARD / RANGEMENTS

	2000	432	740	IM20		105.0	0.150	2	11.655	
	1334	432	740	IM21		59.0	0.122	2	6.549	

MFC TABLE / KLEINER TISCH - MELAMINPLATTE / TABLE - MÉLAMINÉ

	800	800	500	IM57		13.0	0.047	2	1.274	
--	-----	-----	-----	-------------	--	------	-------	---	-------	--

ADDITIONAL CHARGE / AUFFREIS FÜR SONDERAUSSTATTUNG / PLUS VALUE

FEATURE / EIGENSCHAFT / ATTRIBUT	PRODUCT / SYMBOL / PRODUITS											COMMENTS / BEMERKUNGEN / REMARQUES
	IM04	IM05	IM06						kg	m3	pcs	
MEDIABOX M04									0.9	0.0070	1	4x230V, 2xRJ45, 1x USB / 4x230V, 2xRJ45, 1x USB, E-KLASSE, KATEGORIE 6 / 4x230V, 2xRJ45, 1x USB, PRISE CLASSE E.

DESCRIPTION / LEGENDE / LÉGENDE:

net weight / Nettogewicht / poids net

volume / Volumen / le volume

number of packages / Stückzahl der Pakete / nombre de colis

PRODUCT ILLUSTRATION / PRODUKTANSICHT UND SKIZZE / VUE DE PRODUIT	DIMENSIONS / ABMESSUNGEN [mm]			INDEX SYMBOL					ECO	COMMENTS / BEMERKUNGEN / REMARQUES
	WIDTH / BREITE / LARGEUR	DEPTH / TIEFE / PROFONDEUR	HEIGHT / HÖHE / HAUTEUR							

MODESTY PANELS - MFC / KNIEBLENDE - MELAMINPLATTE / VOILES DE FOND - MÉLAMINÉ

	1400	18	350	IM04B		8.0	0.021	2	0.784	desk: 1600mm / für Schreibtisch 1600 mm / bureaux:1600 mm
	1600	18	350	IM05B		9.0	0.023	2	0.882	desks: 1800MM / für Schreibtisch 1800 mm / Concerne les bureaux : 1800 mm
	1800	18	350	IM06B		10.0	0.026	2	0.980	desk: 2000mm / für Schreibtisch 2000 mm / pour bureau en 2000mm

MOBILE HPL FRONT AND TOP PEDESTALS / ROLLCONTAINER MIT FRONT UND OBERKRANZ - HPL / CAISSONS STRATIF

IÉ

	416	600	587	SLD12HT		23.0	0.158	1	2.553	
	416	600	587	SLD13HT		23.0	0.158	1	2.553	

MODULAR TABLES / MODULTISCH / TABLES MODULAIRES

	1200	1400	760	IM53		26.5	0.091	2	2.597	starting element / Anfangstelement / Départ
	1200	1400	760	IM54		22.5	0.091	2	2.205	intermediate element / Mittelement / Intermédiaire
	1200	1400	760	IM55		21.0	0.076	2	2.058	ending element / Endelement / élément final

ADDITIONAL CHARGE / AUFFREIS FÜR SONDERAUSSTATTUNG / PLUS VALUE



FEATURE / EIGENSCHAFT / ATTRIBUT	PRODUCT / SYMBOL / PRODUITS								COMMENTS / BEMERKUNGEN / REMARQUES
	SLD12HT	SLD13HT	IM53	IM54	IM55				
MEDIABOX M04						0.9	0.0070	1	4x230V, 2xRJ45 ,1x USB / 4x230V, 2xRJ45 ,1x USB, E-KLASSE, KATEGORIE 6 / 4x230V, 2xRJ45 ,1x USB, PRISE CLASSE E,
self closing system / Selbstschließsystem / fermeture silencieuse						1.0	0.0010	1	
Ball runners / Kugelführungen / Glissières à billes						1.0	0.0010	1	

DESCRIPTION / LEGENDE / LÉGENDE:



net weight / Nettogewicht / poids net

volume / Volumen / le volume





number of packages / Stückzahl der Pakete / nombre de colis

PRODUCT ILLUSTRATION / PRODUKTANSICHT UND SKIZZE / VUE DE PRODUIT	DIMENSIONS / ABMESSUNGEN [mm]			INDEX SYMBOL					ECO	COMMENTS / BEMERKUNGEN / REMARQUES
	WIDTH / BREITE / LARGEUR	DEPTH / TIEFE / PROFONDEUR	HEIGHT / HÖHE / HAUTEUR			kg	m ³	pcs	EUR	

METAL CABLE TRAYS FOR DESKS / KABELKANÄLE / GUIDE-CABLES

	1496	85	94	EK1200		3.4	0.010	2	0.377	desk: 1600mm / für Schreibtisch 1600 mm / bureaux:1600 mm
	1696	85	94	EK1400		3.9	0.012	2	0.433	desk: 1800mm / für Schreibtisch 1800 mm / bureaux:1800 mm
	1896	85	94	EK1600		4.2	0.013	2	0.466	desk: 2000mm / für Schreibtisch 2000 mm / bureaux:2000 mm

STORAGES WITH HPL FRONT / SCHRÄNKE MIT HPL-FRONT / ARMOIRES AVEC DES FAÇADES EN STRATIFIÉ



	801	432	1833	A5104HZ		75.0	0.215	3	8.325	
	801	432	1833	A5404HZ		65.0	0.189	3	7.215	
	801	432	1129	A3104HZ		44.0	0.120	3	4.884	
	801	432	1129	A3404HZ		40.0	0.111	3	4.440	
	801	432	777	A2104HZ		35.0	0.092	3	3.885	

DESCRIPTION / LEGENDE / LÉGENDE:



 net weight / Nettogewicht / poids net

 volume / Volumen / le volume



 number of packages / Stückzahl der Pakete / nombre de colis

PRODUCT ILLUSTRATION / PRODUKTANSICHT UND SKIZZE / VUE DE PRODUIT	DIMENSIONS / ABMESSUNGEN [mm]			INDEX SYMBOL					ECO	COMMENTS / BEMERKUNGEN / REMARQUES
	WIDTH / BREITE / LARGEUR	DEPTH / TIEFE / PROFONDEUR	HEIGHT / HÖHE / HAUTEUR			kg	m ³	pcs	EUR	

STORAGES WITH GLASS DOORS / VITRINEN / ARMOIRES AVEC DES FAÇADES EN VERRE

	801	432	1833	A5104W		74.0	0.232	3	8.214	glass door in aluminum frame / Glastür im Aluminiumrahmen / porte vitrée, cadre en Aluminium
	801	432	1833	A5404WZ		75.0	0.227	4	8.325	glass door in aluminum frame, hpl door / Glastür im Aluminiumrahmen, Sperrholz-Tür mit HPL-Front / porte vitrée, cadre en Aluminium - porte panneau avec la façade en stratifié
	801	432	1129	A3104W		47.0	0.130	3	5.217	glass door in aluminum frame / Glastür im Aluminiumrahmen / porte vitrée, cadre en Aluminium

ACCESSORIES / ZUBEHÖR / ACCESSOIRES

	77	58	350	IM10		0.5	0.006	1	0.049	vertical hitch, clear plexiglass / vertikale Kabelführung, durchsichtiges Plexiglas / Organisateur de câble vertical, en plexiglas transparent
	275	120	140	M04		0.0	0.000	0	0.000	4x230V, 2xRJ45, 1xUSB

DESCRIPTION / LEGENDE / LÉGENDE:

 net weight / Nettogewicht / poids net

 volume / Volumen / le volume

 number of packages / Stückzahl der Pakete / nombre de colis