

Lane





Lane (Design: Jehs + Laub)

Die mutige Designhandschrift nimmt dem Büroalltag das Alltägliche. Formale Klarheit und effektvolle Emotionalität beeindrucken im Zusammenspiel und unterstreichen den niveauvollen Arbeitsplatz. Verkörpert durch die elegant gebogene, scheinbar aus einem Stück gefertigte Tischplatte, die sich auf ein modulares Korpusssystem – vom Einzelcontainer bis zum Sideboard – stützt. Jedes Detail steht für sichtbare und fühlbare Designqualität. Hochwertige Oberflächen erzeugen einen eindrucksvollen Kontrast. Das Programm unterstützt alle Formen des Arbeitstags: Stehtisch, Rezeption, Loungetisch und Highboard sowie Schreibtische in unterschiedlichen Plattenlängen.

Lane (Design: Jehs + Laub)

The striking signature design boldly takes the commonplace out of the daily routine. Clarity of form is imbued with emotionality to underscore the sophisticated workplace. The elegantly curved tabletop, seemingly formed from one piece, rests on a modular base system featuring everything from a single container to a sideboard. Every detail attests to the visible and tangible quality of design. Premium surfaces provide an impressive contrast. All the needs encountered during the workday can be accommodated with Lane elements: standing desk, reception counter, lounge table and highboard as well as desks in various sizes.



Schreibtisch* mit Container. Desk* with container.

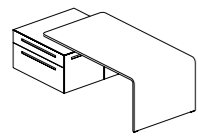

* 180 x 100
Höhe height 73

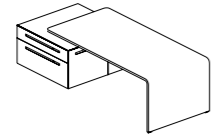

* 200 x 100
Höhe height 73

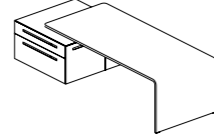

* 220 x 100
Höhe height 73

Schreibtisch* mit mehreren Containern. Desk* with several containers.

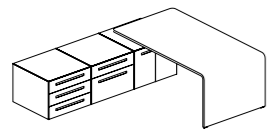

* 180 x 100
Höhe height 73

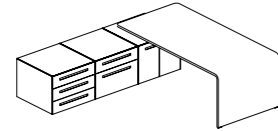

* 200 x 100
Höhe height 73

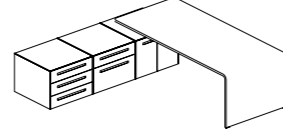

* 220 x 100
Höhe height 73

Container. Container.



70 x 70
Höhe height 23

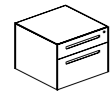

70 x 70
Höhe height 58

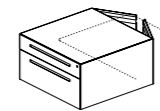

100 x 100
Höhe height 58

Highboard. Highboard.

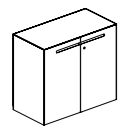

100 x 50
Höhe height 93

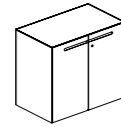

100 x 60
Höhe height 93

Stehtheke* mit 2 Highboards.
Stand counter* with 2 highboards.

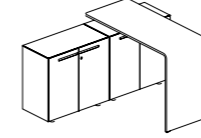

* 160 x 70
Höhe height 108

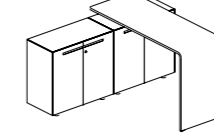

* 180 x 70
Höhe height 108

Loungetisch* mit mehreren Containern.
Lounge table* with several containers..

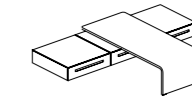

* 160 x 70
Höhe height 38

Theke. Counter.

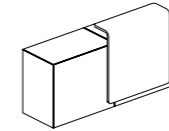

200 x 67
Höhe height 115

Besprechungstisch. Meeting table.

für 4 Personen.
for 4 people



Ø 110
Höhe height 73

für 5 Personen
for 5 people



Ø 125
Höhe height 73

Beispielhafte Schreibtischkonfiguration. Exemplary desk configuration.

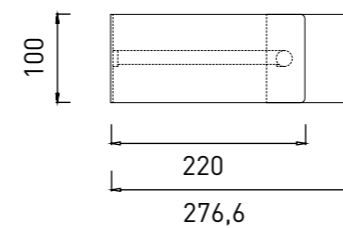

Schreibtischkonfiguration bestehend aus:

Tischplatte L 09	220,0 x 100,0
Container L 55	100,0 x 100,0

Desktop configuration consisting of:

Top L 09	220,0 x 100,0
Container L 55	100,0 x 100,0

Schreibtischkonfiguration bestehend aus:

Tischplatte L 09	220,0 x 100,0
Container L 44	70,0 x 70,0
Container L 43	70,0 x 70,0
Container L 46	70,0 x 70,0

Desktop configuration consisting of:

Top L 09	220,0 x 100,0
Container L 44	70,0 x 70,0
Container L 43	70,0 x 70,0
Container L 46	70,0 x 70,0

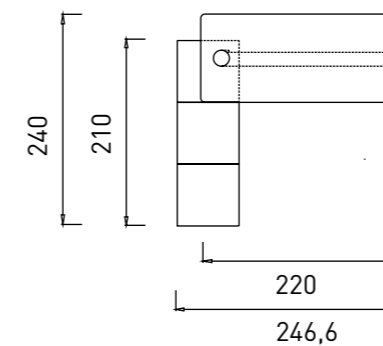



1. Markantes Detail ist der abgerundete Winkel aus Wange und Tischplatte.
2. Horizontaler Kabelkanal aus Aluminium.
3. Lederschiebeplatte mit Utensilienfach und Elektrobox.
4. Container mit Gehrungskanten und eingearbeiteter Griffnut mit verchromter Rückseite.
5. Kabelkanal, geöffnet, mit Elektroleiste und drehbares Verbindungslement.
6. Untertischschublade.

1. The striking detail is the rounded angle of desk top and end panel.
2. Horizontal aluminum cable channel.
3. Sliding leather desk pad with build-in pencil tray and power box.
4. Container with mitred feature and moulded grip plate with a chrome back side.
5. Cable channel, opened, with power strip and a pivotable joint.
6. Drawer underneath desk top.



Birnbaum natur
Pear natural



Eiche matt
Oak matt



Eiche hell
Oak light



Eiche titangrau
Oak grey titan

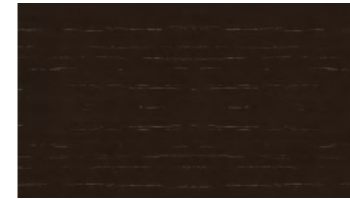

Eiche mocca
Oak mocca



Am. Kirschbaum natur
Am. Cherry natural



Am. Nussbaum natur
Am. Walnut natural



Nussbaum tabac
Walnut tobacco



Makassar
Ebony Makassar



Zebrano grau
Zebrano grey



Zebrano natur
Zebrano natural



Eiche schwarz
Oak black

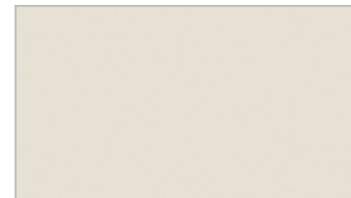

Lack Hochglanz/seidenmatt weiß
Lacquer high gloss/silk matt white

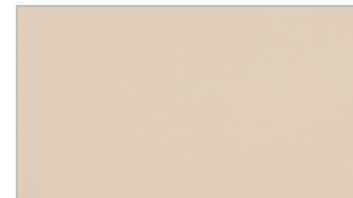

Lack Hochglanz/seidenmatt crema
Lacquer high gloss/silk matt crema

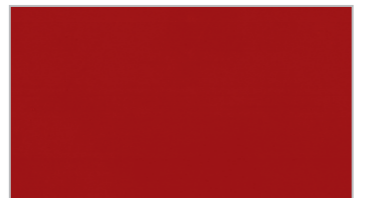

Lack Hochglanz/seidenmatt akzentrot
Lacquer high gloss/silk matt accent red



Lack Hochglanz/seidenmatt anthrazit
Lacquer high gloss/silk matt anthracite

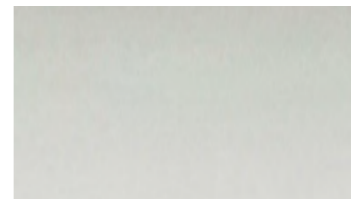

Lack alusilber
Lacquer aluminium silver

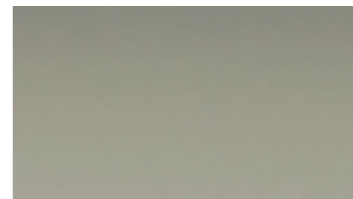

Lack alugrau
Lacquer aluminium grey

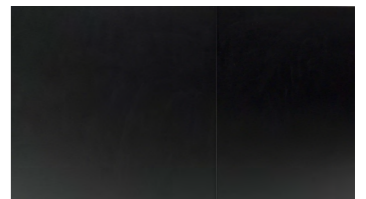

Lack schwarz metallic
Lacquer black metallic

Die abgebildeten Farben sind nicht farbverbindlich. Die Darstellung kann je nach Monitor und Drucker variieren. Weitere Oberflächenausführungen wie Furniere, Laminat und Linoleum nach Muster auf Anfrage.
The colours shown are intended as a guideline only. Their representation may vary depending on the monitor and printer. Further surface finishes such as natural wood veneer, laminate and linoleum on request by sample.

Wilhelm Renz GmbH + Co. KG
Hanns-Klemm-Straße 35
71034 Böblingen
Germany

T +49 (0)7031.21880
F +49 (0)7031.218850

info@renz.de
www.renz.de