

MANAGER DESK / MANAGERSCHREIBTISCHE / BUREAU AVEC DESSERTE

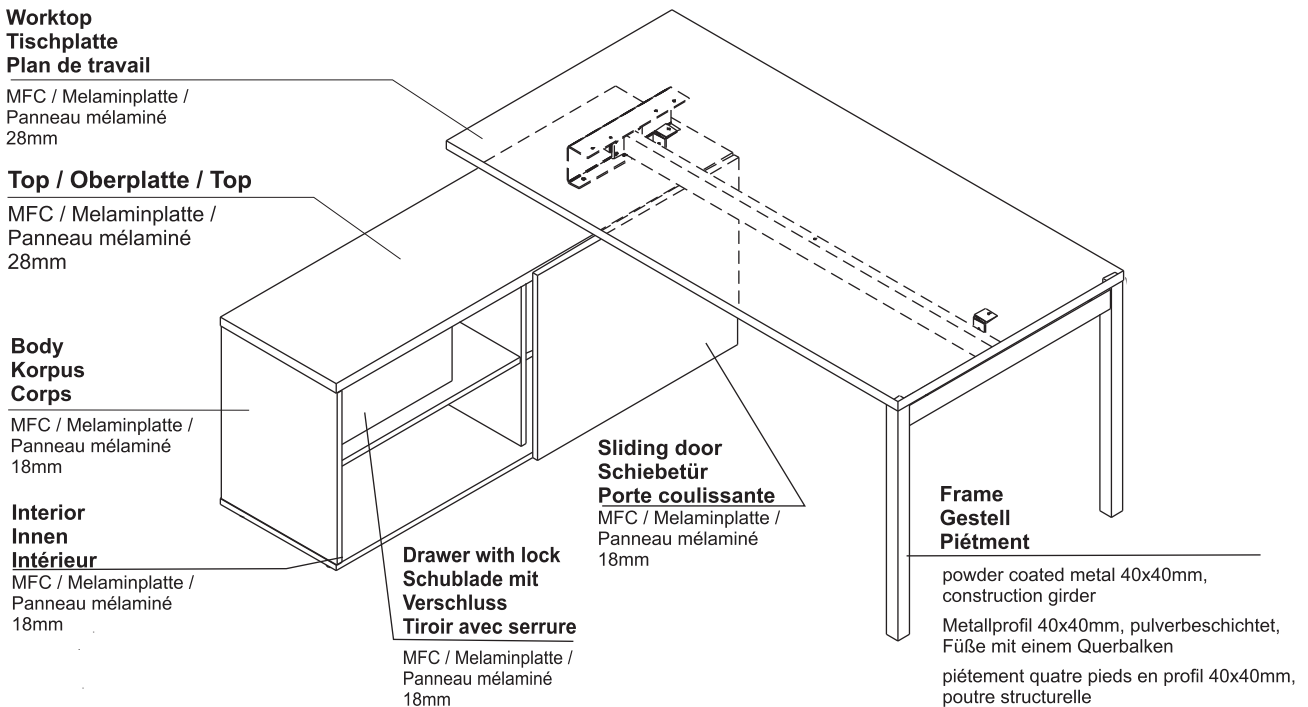

BENCH CONFIGURATIONS / BENCHMONTAGE / CONFIGURATION DU BENCH

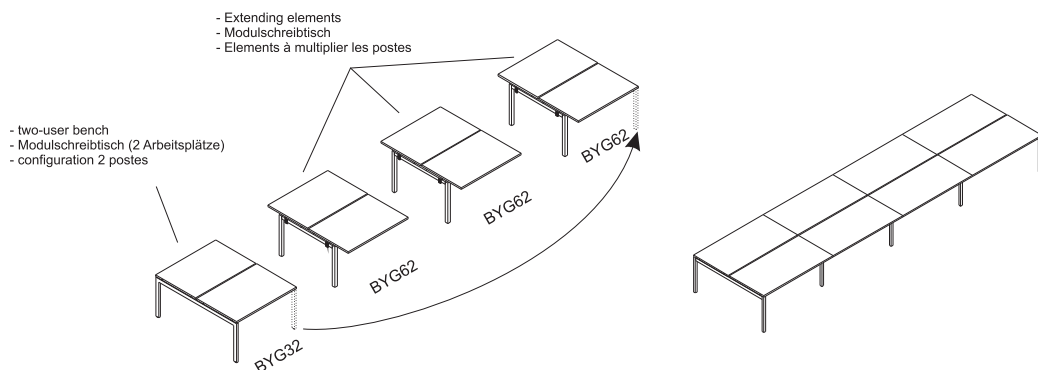

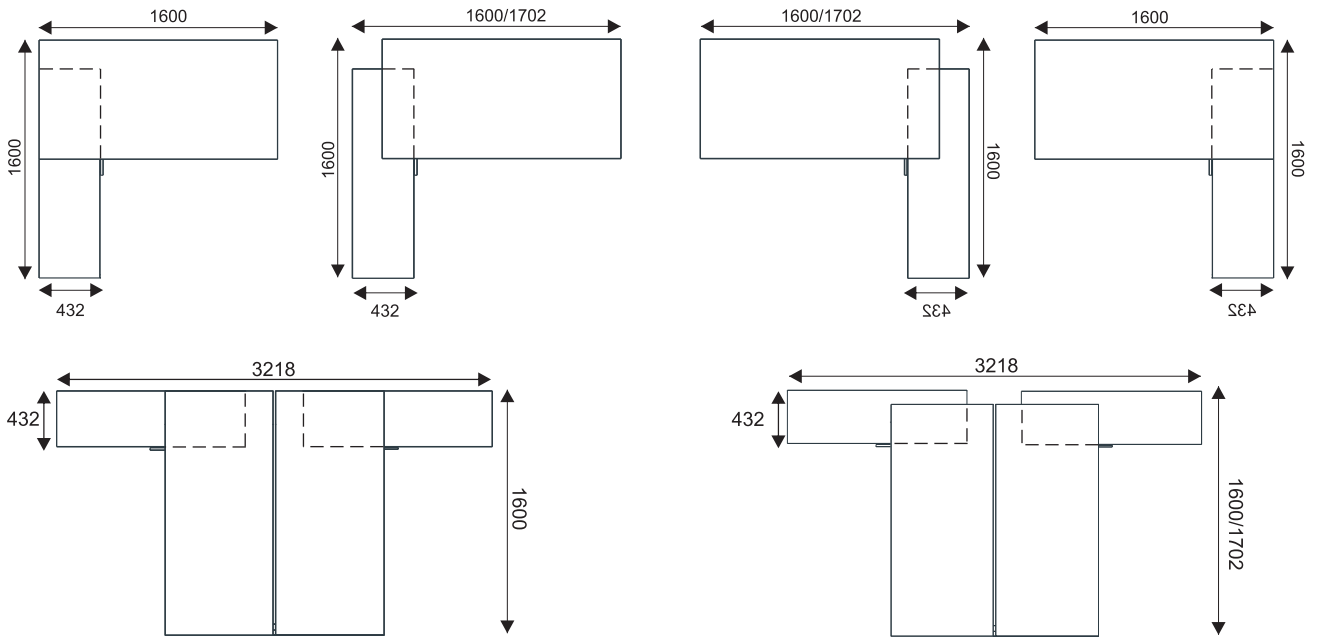

FINISHES / FARBEN / FINITIONS

14-BEECH BUCHE HETRE	31-CANADIAN OAK KANADISCHE EICHE CHENE CANADIEN	34-CHESTNUT WENGE WENGE	39-POLAR BIRCH POLARBIERKE BOULEAU CLAIR	64-COCOA COCOA CACAO	67-WHITE PASTEL WEISS PASTELL BLANC PASTEL	106-LOWLAND NUT NUSSBAUM NOYER	
09-ALUMINIUM ALUMINIUM ALUMINIUM	15-WHITE WEISS BLANC						

MANAGER DESK / MANAGERSCHREIBTISCHE / BUREAU AVEC DESSERTE

Top, Bottom panel / Oberplatte, Sockel / Top, Plinthe

14-BEECH BUCHE HETRE	31-CANADIAN OAK KANADISCHE EICHE CHENE CANADIEN	34-CHESTNUT WENGE WENGE	39-POLAR BIRCH POLARBIERKE BOULEAU CLAIR	64-COCOA COCOA CACAO	67-WHITE PASTEL WEISS PASTELL BLANC PASTEL	106-LOWLAND NUT NUSSBAUM NOYER	
----------------------------	---	-------------------------------	--	----------------------------	--	--------------------------------------	--

Front / Front / Façade

14-BEECH BUCHE HETRE	31-CANADIAN OAK KANADISCHE EICHE CHENE CANADIEN	34-CHESTNUT WENGE WENGE	39-POLAR BIRCH POLARBIERKE BOULEAU CLAIR	64-COCOA COCOA CACAO	67-WHITE PASTEL WEISS PASTELL BLANC PASTEL	106-LOWLAND NUT NUSSBAUM NOYER	
----------------------------	---	-------------------------------	--	----------------------------	--	--------------------------------------	--

Body / Korpus / Corps

26-ALUMINIUM SATINATO ALUMINIUM SATINATO ALUMINIUM SATINE	67-WHITE PASTEL WEISS PASTELL BLANC PASTEL						I - first group I – erste Gruppe I – première groupe de prix	
14-BEECH BUCHE HETRE	31-CANADIAN OAK KANADISCHE EICHE CHENE CANADIEN	34-CHESTNUT WENGE WENGE	39-POLAR BIRCH POLARBIERKE BOULEAU CLAIR	64-COCOA COCOA CACAO		106-LOWLAND NUT NUSSBAUM NOYER	II – second group II – zweite Gruppe II – deuxième groupe de prix	

Configuration of cable rack bracket PK80 / Konfiguration von den Durchlässen PK80 / Configuration de passage de câble PK80

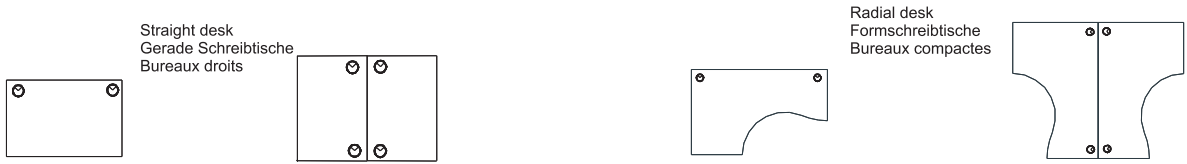

Configuration of M04/M05 / Konfiguration von M04/M05 / Configuration de M04/M05

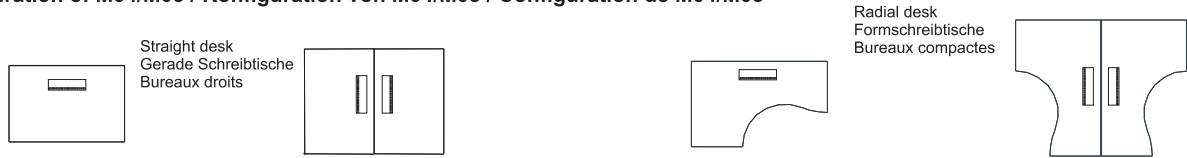

CABLE GROMMET COLORS ASSIGNED TO THE COLOR OF THE WORKTOP /
DIE FARBE VON DEN KABELDURCHLÄSSEN WIRD AN DIE FARBE DER ARBEITSPLATTE ANGEPAßT /
COULEURS DE PASSAGES DE CÂBLES COMPATIBLES AVEC LES COULEURS DE PLANS DE TRAVAIL

Colour of M04 / M05
Farbe der Mediabox M04 / M05
Couleur mediabox M04 / M05

BLACK CABLE GROMMET FOR THE TOPS IN THE FOLLOWING COLORS: /
SCHWARZER KABELDURCHLASS FÜR ARBEITSPLATTEN IN: /
PASSES-CABLES NOIRS POUR LES PLANS DE TRAVAIL EN COULEURS SUIVANTS:

- 08 - BLACK / SCHWARZ / NOIR
- 112 - DARK SYCAMORE / PLATANE DUNKEL / SYCAMORE FONCÉ
- 106 - LOWLAND NUT / NUSSBAUM / NOYER
- 34 - CHESTNUT / WENGE / WENGE
- 64 - COCOA

GRAY CABLE GROMMET FOR WORKTOPS IN THE FOLLOWING COLORS: /
GRAUER KABELDURCHLASS FÜR ARBEITSPLATTEN IN: /
PASSES-CABLES GRIS POUR LES PLANS DE TRAVAIL EN COULEURS SUIVANTS:

- 14 - BEECH / BUCHE / HETRE
- 31 - CANADIAN OAK / KANADISCHE EICHE / CHENE CANADIEN
- 39 - POLAR BIRCH / POLARBIERKE / BOULEAU CLAIR
- 111 - LIGHT SYCAMORE / PLATANE HELL / SYCAMORE CLAIR

WHITE CABLE GROMMET FOR THE TOPS IN THE FOLLOWING COLORS: /
WEISSER KABELDURCHLASS FÜR ARBEITSPLATTEN IN: /
PASSES-CABLES BLANCS POUR LES PLANS DE TRAVAIL EN COULEURS SUIVANTS:

- 67 - WHITE PASTEL / WEIß PASTELL / BLANC PASTEL

09 - ALUMINUM / ALUMINIUM / ALUMINIUM

PRODUCT ILLUSTRATION / PRODUKTANSICHT UND SKIZZE / VUE DE PRODUIT	DIMENSIONS / ABMESSUNGEN [mm]			INDEX SYMBOL						COMMENTS / BEMERKUNGEN / REMARQUES
	WIDTH / BREITE / LARGEUR	DEPTH / TIEFE / PROFONDEUR	HEIGHT / HÖHE / HAUTEUR			kg	m3	pcs		

STRAIGHT DESKS / SCHREIBTISCHE - EINFACH / BUREAUX

	1200	800	740	BYG02		30.8	0.071	3		
	1400	800	740	BYG03		34.1	0.077	3		
	1600	800	740	BYG04		37.0	0.084	3		
	1800	800	740	BYG05		40.4	0.089	3		

RADIAL DESKS / FORMSCHREIBTISCHE / BUREAUX COMPACTS



	1600	1200	740	BYG10		12.0	0.036	2		use adequate supporting leg / es ist ein entsprechender Stützfuß einzusetzen / utiliser le pied de soutien approprié
	1600	1200	740	BYG11		41.5	0.106	3		use adequate supporting leg / es ist ein entsprechender Stützfuß einzusetzen / utiliser le pied de soutien approprié
	1800	1200	740	BYG17		48.0	0.114	3		use adequate supporting leg / es ist ein entsprechender Stützfuß einzusetzen / utiliser le pied de soutien approprié
	1800	1200	740	BYG18		48.0	0.114	3		use adequate supporting leg / es ist ein entsprechender Stützfuß einzusetzen / utiliser le pied de soutien approprié
	1600	2418	740	BYG15		315.4	0.818	15		use adequate supporting leg / es ist ein entsprechender Stützfuß einzusetzen / il faut ajouter un pied de support convenable

DESCRIPTION / LEGENDE / LÉGENDE:

net weight / Nettogewicht / poids net

volume / Volumen / le volume

number of packages / Stückzahl der Pakete / nombre de colis

PRODUCT ILLUSTRATION / PRODUKTANSICHT UND SKIZZE / VUE DE PRODUIT	DIMENSIONS / ABMESSUNGEN [mm]			INDEX SYMBOL						COMMENTS / BEMERKUNGEN / REMARQUES
	WIDTH / BREITE / LARGEUR	DEPTH / TIEFE / PROFONDEUR	HEIGHT / HÖHE / HAUTEUR			kg	m3	pcs		

MANAGERIAL DESK WITH STORAGE / SCHREIBTISCHE MIT MANAGERSCHRANK / BUREAU AVEC DESSERT

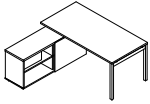
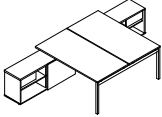
	1702	1600	740	BYL20		92.7	0.244	9		universal system, left or right / universal, links oder rechts / module universel, droit ou gauche
	1600	1600	740							
	1702	3218	740	BYL40	1 020,-	181.2	0.473	16		
	1600	3218	740							

EXTENDING ELEMENT / BAUTEIL FÜR SYSTEMAUSBAU / ÉLÉMENTS À MULTILIER LES POSTES

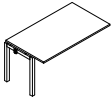
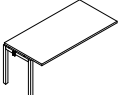
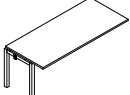

	1200	800	740	BYG42		25.8	0.073	3		
	1400	800	740	BYG43		29.1	0.079	3		
	1600	800	740	BYG44		32.0	0.086	3		
	1800	800	740	BYG45		35.4	0.091	3		

DESCRIPTION / LEGENDE / LÉGENDE:

 net weight / Nettogewicht / poids net

 volume / Volumen / le volume

 number of packages / Stückzahl der Pakete / nombre de colis

PRODUCT ILLUSTRATION / PRODUKTANSICHT UND SKIZZE / VUE DE PRODUIT	DIMENSIONS / ABMESSUNGEN [mm]			INDEX SYMBOL						COMMENTS / BEMERKUNGEN / REMARKES
	WIDTH / BREITE / LARGEUR	DEPTH / TIEFE / PROFONDEUR	HEIGHT / HÖHE / HAUTEUR			kg	m3	pcs		

OGI Y BENCH / BENCH OGI Y

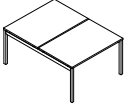
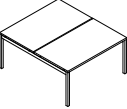
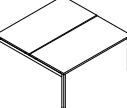
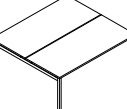
	1200	1618	740	BYG32		56.5	0.180	5		
	1400	1618	740	BYG33		63.2	0.191	5		
	1600	1618	740	BYG34		69.0	0.206	5		Extension not possible /
	1800	1618	740	BYG35		81.8	0.216	5		

EXTENDING ELEMENT / BAUTEIL FÜR SYSTEMAUSBAU / ÉLÉMENTS À MULTIPLIER LES POSTES

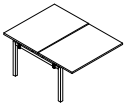
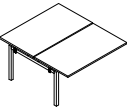
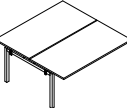
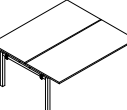
	1200	1618	740	BYG62		49.5	0.144	5		
	1400	1618	740	BYG64		56.2	0.156	5		
	1600	1618	740	BYG66		62.0	0.170	5		
	1800	1618	740	BYG68		68.8	0.181	5		

DESCRIPTION / LEGENDE / LÉGENDE:

 net weight / Nettogewicht / poids net

 volume / Volumen / le volume

 number of packages / Stückzahl der Pakete / nombre de colis