

**TECHNICAL SPECIFICATION / TECHNISCHE BESCHREIBUNG / DESCRIPTION TECHNIQUE**

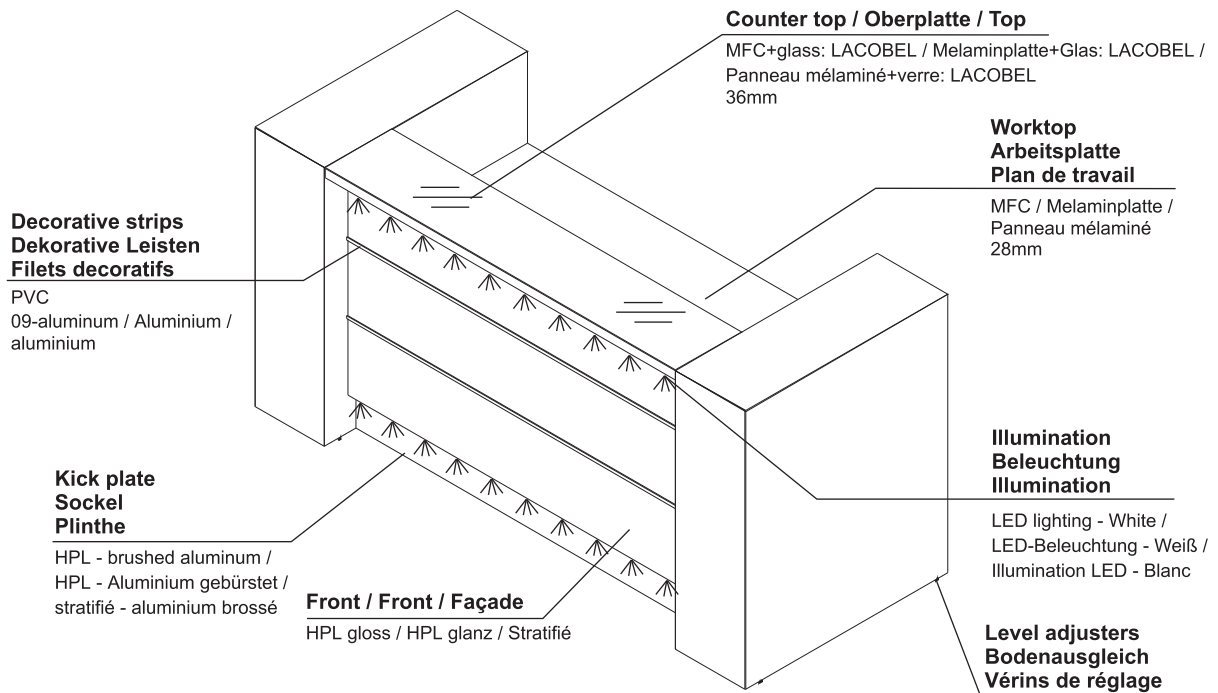

**Cable-way  
Kabeldurchlass  
Obturateur**  
ø 80mm

**Worktop with optional  
monitor shelf(160 EURO)  
Arbeitsplatte mit  
Monitorboden (als Option)  
Plan de travail avec support  
moniteur en option**

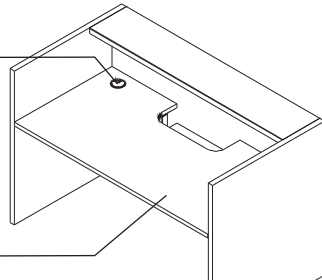

**Side panel / Wangenfuß / Pied latéral**

HPL gloss / HPL glanz / Stratifié  
38mm

**Side panel  
Wangenfuß niedrig  
Pied latéral**

HPL gloss / HPL glanz / Stratifié  
38mm

**Side panel  
Endungselement  
Element de finition de  
la rehausse**

HPL gloss / HPL glanz / Stratifié  
38mm

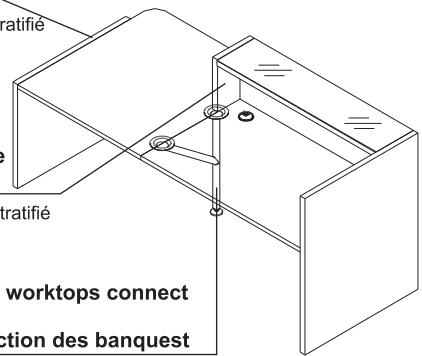

**Supporting leg where worktops connect  
Stützfuß  
Nécessaire sur la jonction des banquettes**

NL41 required on all connections of receptions /  
NL41 Stützfuß zusätzlich zur Verbindung der  
Thekenelemente bestellen /  
NL41 nécessaire sur la connexion des banquettes

METAL, HIGH GLOSS WHITE  
METALL, WEIß GLANZ  
METAL, BLANC BRILLANT

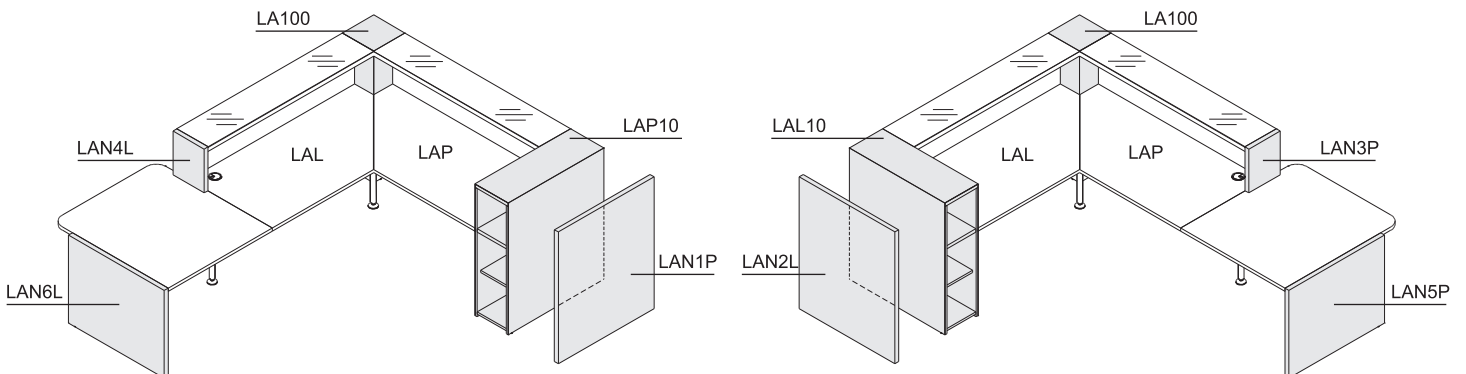

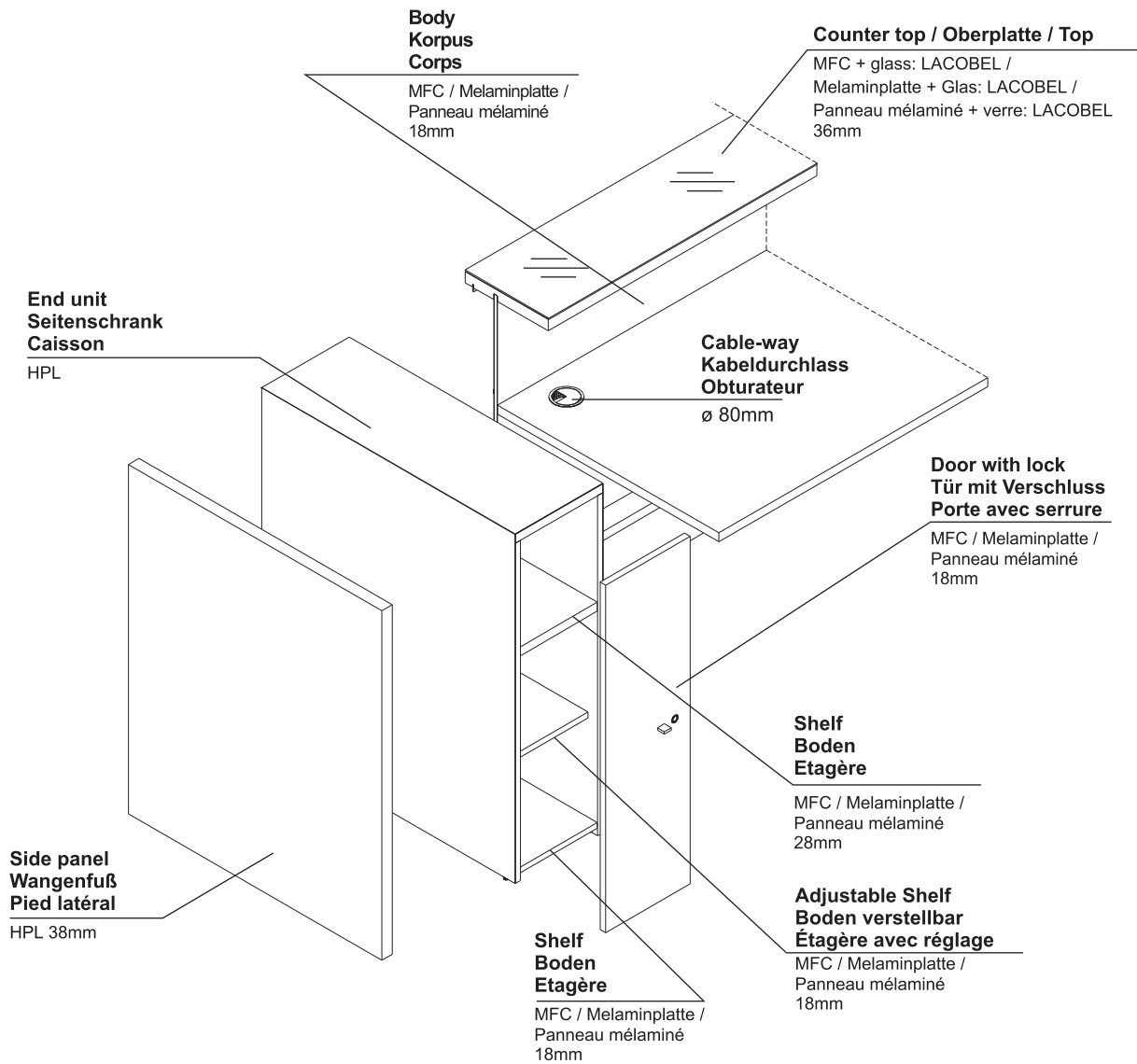
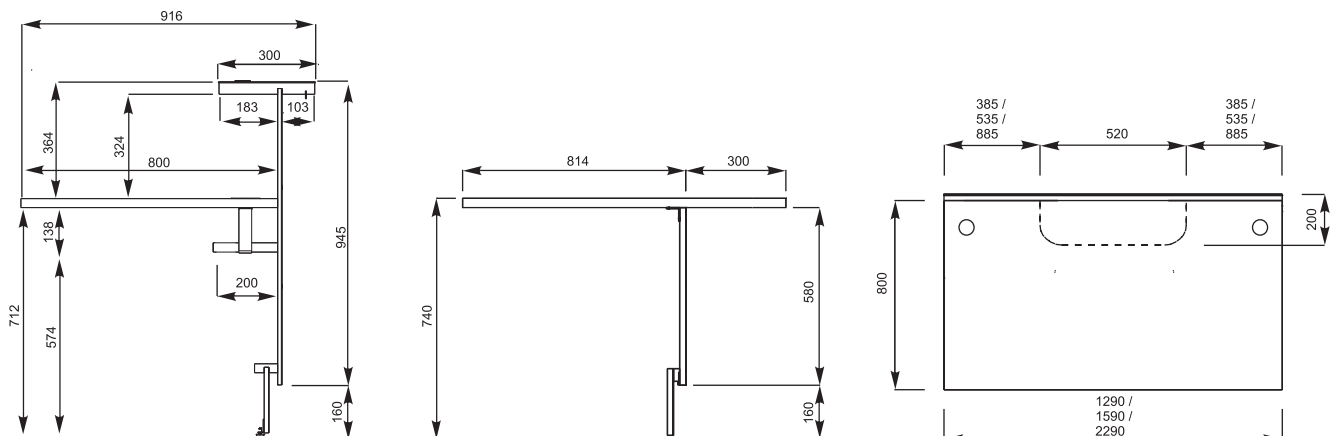
**TECHNICAL SPECIFICATION / TECHNISCHE BESCHREIBUNG / DESCRIPTION TECHNIQUE**

**DIMENSIONS / ABMESSUNG / DIMENSIONS**

**TECHNICAL SPECIFICATION / TECHNISCHE BESCHREIBUNG / DESCRIPTION TECHNIQUE**
**Top  
Oberplatte  
Plateau**

 MFC / Melaminplatte /  
Panneau mélaminé  
12mm

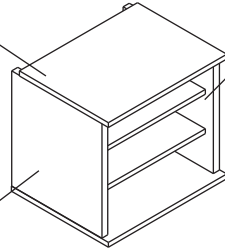
**Body  
Korpus  
Corps**

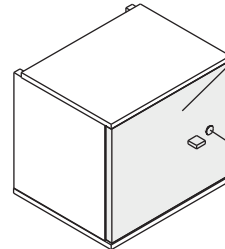
 MFC / Melaminplatte /  
Panneau mélaminé  
18mm

**Shelf  
Boden  
Plateau**





 MFC / Melaminplatte /  
Panneau mélaminé  
12mm

**Door  
Tür  
Porte**

 MFC / Melaminplatte /  
Panneau mélaminé  
18mm

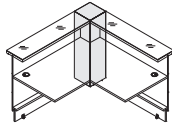
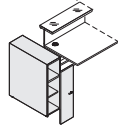
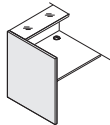
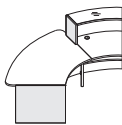
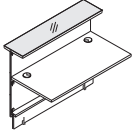
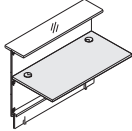
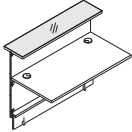
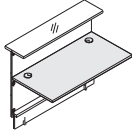
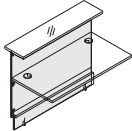
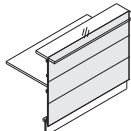

**Lock / Verschluss / Serrure**

- central lock
- Zentralverschluss
- serrure centralisée

**FINISHES / FARBEN / FINITIONS**

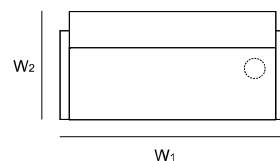
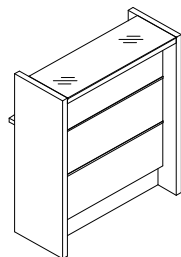

73-HIGH GLOSS WHITE WEIß GLANZ BLANC BRILLANT	148-HIGH GLOSS GRAY GRAU GLANZ GRIS BRILLANT				
GLASS LACOBEL, WHITE GLAS LACOBEL, WEIß VERRE LAQUÉ LACOBEL, BLANC	67-WHITE PASTEL WEIß PASTELL BLANC PASTEL				
GLASS LACOBEL, WHITE GLAS LACOBEL, WEIß VERRE LAQUÉ LACOBEL, BLANC	26-ALUMINIUM SATINATO ALUMINIUM SATINATO ALUMINIUM SATINE				
67-WHITE PASTEL WEIß PASTELL BLANC PASTEL					
31-CANADIAN OAK KANADISCHE EICHE CHENE CANADIEN	34-CHESTNUT WENGE WENGE	73-HIGH GLOSS WHITE WEIß GLANZ BLANC BRILLANT	74-HIGH GLOSS ORANGE ORANGE GLANZ ORANGE BRILLANT		
80-HIGH GLOSS LIME GRÜN GLANZ VERT BRILLANT	81-HIGH GLOSS BURGUNDY DUNKELROT GLANZ BORDEAUX BRILLANT	102-HIGH GLOSS YELLOW GELB GLANZ JAUNE BRILLANT	127-HIGH GLOSS FUCHSIA PINK GLANZ ROSE BRILLANT		
15-HIGH GLOSS WHITE WEIß GLANZ BLANC BRILLANT	NL41 				
26-ALUMINIUM SATINATO ALUMINIUM SATINATO ALUMINIUM SATINE	67-WHITE PASTEL WEIß PASTELL BLANC PASTEL				

**RECEPTION DESK SYSTEMS / EMPFANGSTHEKEN-SYSTEME / CONFIGURATIONS DES BANQUES**

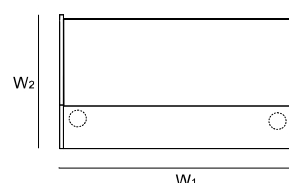
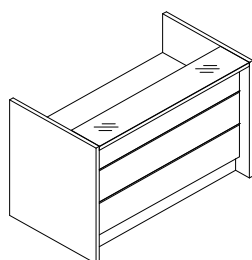
INDEX SYMBOL	DIMENSIONS / ABMESSUNGEN [mm]									COMMENTS / BEMERKUNGEN / REMARQUES
	W <sub>1</sub>	W <sub>2</sub>	D <sub>1</sub>	D <sub>2</sub>	H		kg	m <sup>3</sup>	pcs	
<b>LAV96L</b>	920	454	-	-	1105		51.5	0.182	7	



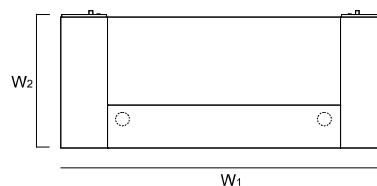
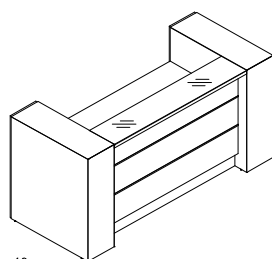

09  
13  
16  
LAN1P+LA23L+LAN2L

INDEX SYMBOL	DIMENSIONS / ABMESSUNGEN [mm]									COMMENTS / BEMERKUNGEN / REMARQUES
	W <sub>1</sub>	W <sub>2</sub>	D <sub>1</sub>	D <sub>2</sub>	H		kg	m <sup>3</sup>	pcs	
<b>LAV95L</b> <sup>09</sup>	920	917	-	-	1105		88.0	0.252	6	
<b>LAV75L</b> <sup>13</sup>	1366	917	-	-	1105		127.6	0.369	8	
<b>LAV76L</b> <sup>16</sup>	1666	917	-	-	1105		145.5	0.424	8	
<b>LAV77L</b> <sup>23</sup>	2366	917	-	-	1105		182.0	0.584	9	



13  
16  
LAD10+LAP10+LA23L+LAL10+LAD10

INDEX SYMBOL	DIMENSIONS / ABMESSUNGEN [mm]									COMMENTS / BEMERKUNGEN / REMARQUES
	W <sub>1</sub>	W <sub>2</sub>	D <sub>1</sub>	D <sub>2</sub>	H		kg	m <sup>3</sup>	pcs	
<b>LAV01L</b> <sup>13</sup>	1926	937	-	-	1105		185.6	1.031	10	
<b>LAV02L</b> <sup>16</sup>	2226	937	-	-	1105		203.5	1.087	10	
<b>LAV03L</b> <sup>23</sup>	2926	937	-	-	1105		240.0	1.246	11	

DESCRIPTION / LEGENDE / LÉGENDE:

 net weight / Nettogewicht / poids net

 volume / Volumen / le volume

 number of packages / Stückzahl der Pakete / nombre de colis

**RECEPTION DESK SYSTEMS / EMPFANGSTHEKEN-SYSTEME / CONFIGURATIONS DES BANQUES**

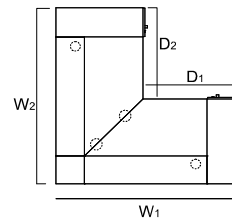
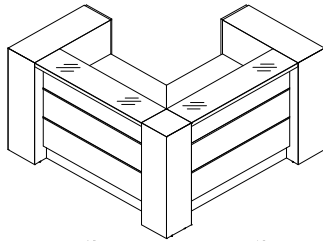

LAD10+LAP10+LAP23L+LA100+NL41+LAL23L+LAL10+LAD10

INDEX SYMBOL	DIMENSIONS / ABMESSUNGEN [mm]						⚖️	📦	📦		COMMENTS / BEMERKUNGEN / REMARQUES
	W <sub>1</sub>	W <sub>2</sub>	D <sub>1</sub>	D <sub>2</sub>	H						
13 <b>LAV10L</b> 13	1908	1908	991	991	1105		242.4	1.394	15		
13 <b>LAV11L</b> 16	1908	2208	991	1291	1105		262.3	1.452	17		
13 <b>LAV12L</b> 23	1908	2908	991	1991	1105		288.8	1.591	18		
16 <b>LAV13L</b> 13	2208	1908	1291	991	1105		262.3	1.452	17		
16 <b>LAV14L</b> 16	2208	2208	1291	1291	1105		270.2	1.488	15		
16 <b>LAV15L</b> 23	2208	2908	1291	1991	1105		302.7	1.638	18		
23 <b>LAV16L</b> 13	2908	1908	1991	991	1105		288.8	1.591	18		
23 <b>LAV17L</b> 16	2908	2208	1991	1291	1105		302.7	1.638	18		
23 <b>LAV18L</b> 23	2908	2908	1991	1991	1105		323.2	1.767	17		

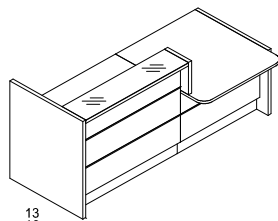

A

B

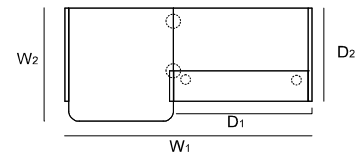
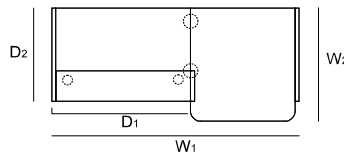

A: LAN1P+LA23L+NL41+LAN4L+LAU11L+LAN6L  
 B: LAN5P+LAU11L+NL41+LAN3P+LA23L+LAN2L

INDEX SYMBOL		DIMENSIONS / ABMESSUNGEN [mm]						⚖️	📦	📦		COMMENTS / BEMERKUNGEN / REMARQUES
A	B	W <sub>1</sub>	W <sub>2</sub>	D <sub>1</sub>	D <sub>2</sub>	H						
13 <b>LAV19L</b> 13	13 <b>LAV20L</b> 13	2366	1114	1328	917	1105		138.9	0.509	12		
16 <b>LAV21L</b> 16	16 <b>LAV22L</b> 16	2666	1114	1628	917	1105		152.3	0.556	12		
23 <b>LAV23L</b> 23	23 <b>LAV24L</b> 23	3366	1114	2318	917	1105		178.8	0.695	13		

DESCRIPTION / LEGENDE / LÉGENDE:

⚖️ net weight / Nettogewicht / poids net

📦 volume / Volumen / le volume

📦 number of packages / Stückzahl der Pakete / nombre de colis

**RECEPTION DESK SYSTEMS / EMPFANGSTHEKEN-SYSTEME / CONFIGURATIONS DES BANQUES**

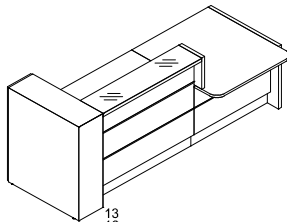

A

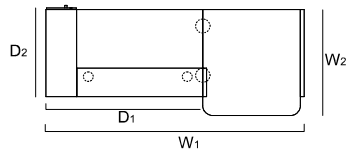

B

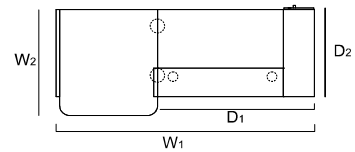

A: LAD10+LAP10+LA23L+NL41+LAN4L+LAU11L+LAN6L

B: LAN5P+LAU11L+NL41+LAN3P+LA23L+LAL10+LAD10

INDEX SYMBOL		DIMENSIONS / ABMESSUNGEN [mm]						⚖️	📦	📦		COMMENTS / BEMERKUNGEN / REMARQUES
A	B	W <sub>1</sub>	W <sub>2</sub>	D <sub>1</sub>	D <sub>2</sub>	H						
LAV41L <sup>13</sup>	LAV42L <sup>13</sup>	2646	1134	1608	937	1105		167.9	0.840	13		
LAV43L <sup>16</sup>	LAV44L <sup>16</sup>	2946	1134	1908	937	1105		171.8	0.875	13		
LAV45L <sup>23</sup>	LAV46L <sup>23</sup>	3646	1134	2608	937	1105		207.8	1.026	14		

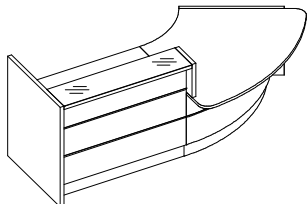

A

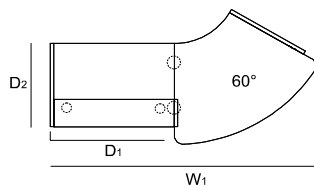

B

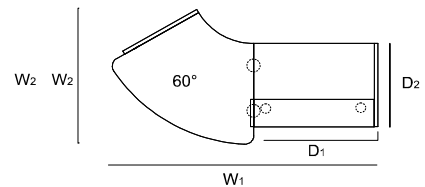

A: LAN1P+LA23L+NL41+LAN4L+LAV66L+LAN6L

B: LAN5P+LAV66L+NL41+LAN3P+LA23L+LAN2L

INDEX SYMBOL		DIMENSIONS / ABMESSUNGEN [mm]						⚖️	📦	📦		COMMENTS / BEMERKUNGEN / REMARQUES
A	B	W <sub>1</sub>	W <sub>2</sub>	D <sub>1</sub>	D <sub>2</sub>	H						
LAV88L <sup>13</sup>	LAV89L <sup>13</sup>	2845	1111	1328	917	1105		160.9	0.832	12		
LAV91L <sup>16</sup>	LAV92L <sup>16</sup>	3145	1111	1628	917	1105		174.3	0.879	12		
LAV93L <sup>23</sup>	LAV94L <sup>23</sup>	3845	1111	2318	917	1105		200.8	1.018	13		

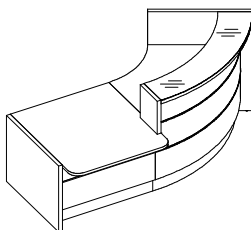

A

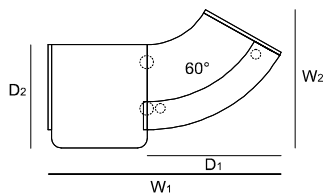

B

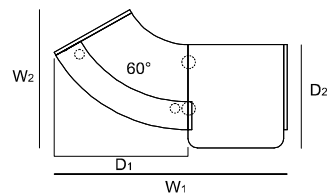

A: LAN5P+LAU11L+NL41+LAN3P+LAV64L+LAN2L

B: LAN1P+LAV64L+NL41+LAN4L+LAU11L+LAN6L

INDEX SYMBOL		DIMENSIONS / ABMESSUNGEN [mm]						⚖️	📦	📦		COMMENTS / BEMERKUNGEN / REMARQUES
A	B	W <sub>1</sub>	W <sub>2</sub>	D <sub>1</sub>	D <sub>2</sub>	H						
LAV84L	LAV85L	2443	1489	1404	1114	1105		149.8	0.957	12		

DESCRIPTION / LEGENDE / LÉGENDE:

⚖️ net weight / Nettogewicht / poids net

📦 volume / Volumen / le volume

📦 number of packages / Stückzahl der Pakete / nombre de colis

## RECEPTION DESK SYSTEMS / EMPFANGSTHEKEN-SYSTEME / CONFIGURATIONS DES BANQUES

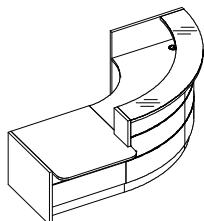

A

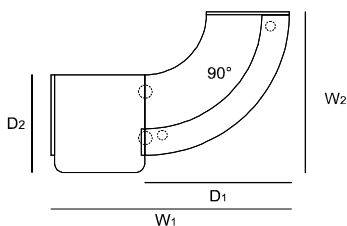

B

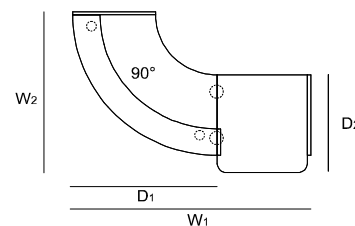

A: LAN5P+LAU11L+NL41+LAN3P+LAV90L+LAN2L

B: LAN1P+LAV90L+NL41+LAN4L+LAU11L+LAN6L

INDEX SYMBOL		DIMENSIONS / ABMESSUNGEN [mm]										COMMENTS / BEMERKUNGEN / REMARQUES
A	B	W <sub>1</sub>	W <sub>2</sub>	D <sub>1</sub>	D <sub>2</sub>	H						
LAV86L	LAV87L	2638	1835	1600	937	1105		190.8	1.328	13		

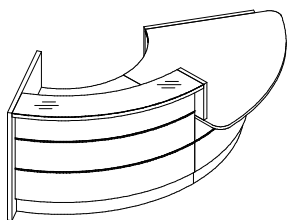

A

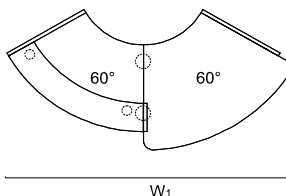

B

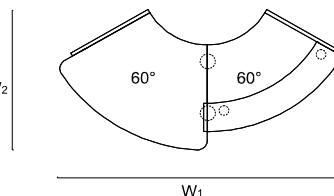

A: LAN1P+LAV64L+NL41+LAN4L+LAV66L+LAN6L

B: LAN5P+LAV66L+NL41+LAN3P+LAV64L+LAN2L

INDEX SYMBOL		DIMENSIONS / ABMESSUNGEN [mm]										COMMENTS / BEMERKUNGEN / REMARQUES
A	B	W <sub>1</sub>	W <sub>2</sub>	D <sub>1</sub>	D <sub>2</sub>	H						
LAV30L	LAV31L	2922	1486	-	-	1105		171.8	1.280	12		

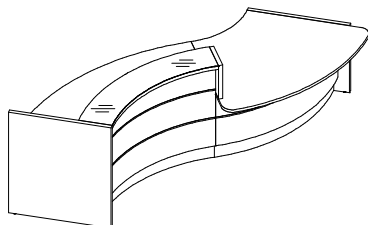

A

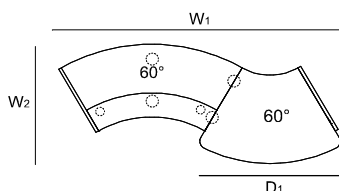

B

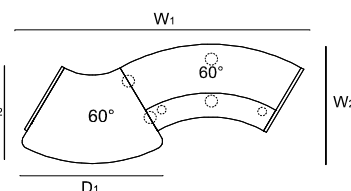

A: LAN1P+LAV62L+NL41+LAN4L+LAV66L+LAN6L

B: LAN5P+LAV66L+NL41+LAN3P+LAV62L+LAN2L

INDEX SYMBOL		DIMENSIONS / ABMESSUNGEN [mm]										COMMENTS / BEMERKUNGEN / REMARQUES
A	B	W <sub>1</sub>	W <sub>2</sub>	D <sub>1</sub>	D <sub>2</sub>	H						
LAV32L	LAV33L	3452	1502	1720	1225	1105		182.8	1.366	13		

DESCRIPTION / LEGENDE / LÉGENDE:

net weight / Nettogewicht / poids net

volume / Volumen / le volume

number of packages / Stückzahl der Pakete / nombre de colis

**RECEPTION DESK SYSTEMS / EMPFANGSTHEKEN-SYSTEME / CONFIGURATIONS DES BANQUES**

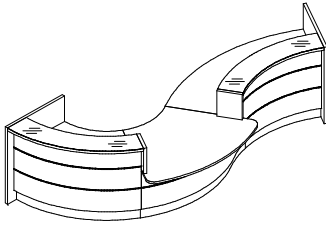

A

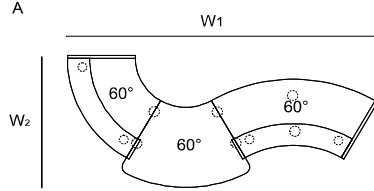

B

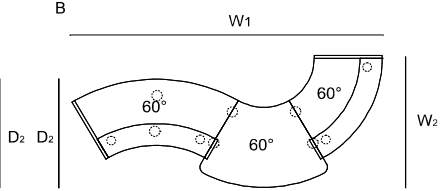

A: LAN1P+LAV64L+NL41+LAN4L+LAV66L+NL41+LAN3P+LAV62L+LAN2L  
 B: LAN1P+LAV62L+NL41+LAN4L+LAV66L+NL41+LAN3P+LAV64L+LAN2L

INDEX SYMBOL		DIMENSIONS / ABMESSUNGEN [mm]						⚖	📦	📦		COMMENTS / BEMERKUNGEN / REMARQUES
A	B	W <sub>1</sub>	W <sub>2</sub>	D <sub>1</sub>	D <sub>2</sub>	H						
<b>LAV34L</b>	<b>LAV35L</b>	4195	1835	-	1503	1105	262.1	2.129	20			

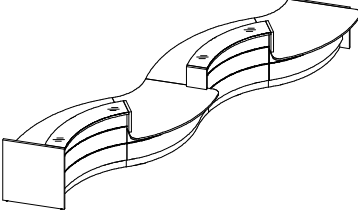

A

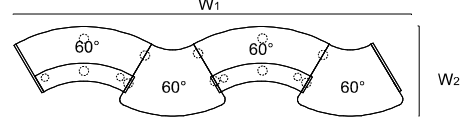

B

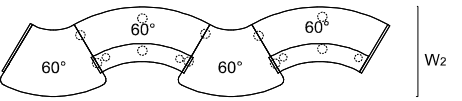

A: LAN1P+LAV62L+NL41+LAN4L+LAV66L+NL41+LAN3P+LAV62L+NL41+LAN4L+LAV66L+LAN6L  
 B: LAN5P+LAV66L+NL41+LAN3P+LAV62L+NL41+LAN4L+LAV66L+NL41+LAN3P+LAV62L+LAN2L

INDEX SYMBOL		DIMENSIONS / ABMESSUNGEN [mm]						⚖	📦	📦		COMMENTS / BEMERKUNGEN / REMARQUES
A	B	W <sub>1</sub>	W <sub>2</sub>	D <sub>1</sub>	D <sub>2</sub>	H						
<b>LAV36L</b>	<b>LAV37L</b>	6352	1503	-	-	1105	322.1	2.706	24			

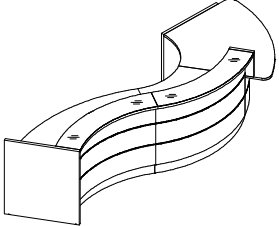

A

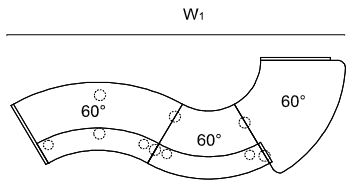

B

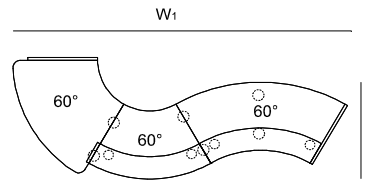

A: LAN1P+LAV62L+NL41+LAV64L+NL41+LAN4L+LAV66L+LAN6L  
 B: LAN5P+LAV66L+NL41+LAN3P+LAV64L+NL41+LAV62L+LAN2L

INDEX SYMBOL		DIMENSIONS / ABMESSUNGEN [mm]						⚖	📦	📦		COMMENTS / BEMERKUNGEN / REMARQUES
A	B	W <sub>1</sub>	W <sub>2</sub>	D <sub>1</sub>	D <sub>2</sub>	H						
<b>LAV38L</b>	<b>LAV39L</b>	4386	1639	-	1307	1105	252.3	2.106	19			

DESCRIPTION / LEGENDE / LÉGENDE:

⚖ net weight / Nettogewicht / poids net

📦 volume / Volumen / le volume

📦 number of packages / Stückzahl der Pakete / nombre de colis



**RECEPTION DESK SYSTEMS / EMPFANGSTHEKEN-SYSTEME / CONFIGURATIONS DES BANQUES**

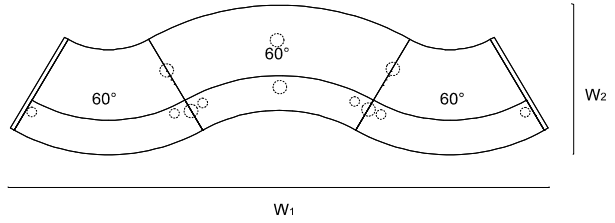
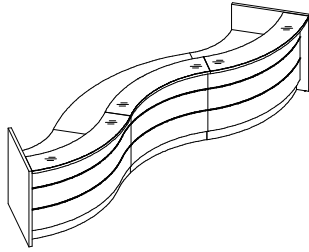

LAN1P+LAV64L+NL41+LAV62L+NL41+LAV64L+LAN2L

INDEX SYMBOL	DIMENSIONS / ABMESSUNGEN [mm]						⚖️	📦	📦		COMMENTS / BEMERKUNGEN / REMARQUES
	W <sub>1</sub>	W <sub>2</sub>	D <sub>1</sub>	D <sub>2</sub>	H						
<b>LAV50L</b>	4566	1307	-	-	1105		269.5	2.345	20		

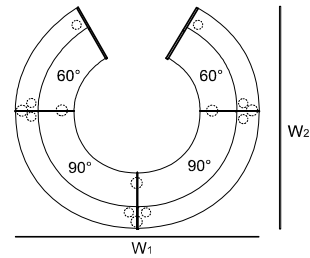
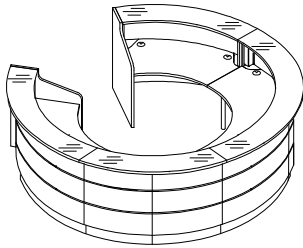

LWN1P+LWC64L+NL41+LWC90L+NL41+LWC90L+NL41+LWC64L+LWN2L

INDEX SYMBOL	DIMENSIONS / ABMESSUNGEN [mm]						⚖️	📦	📦		COMMENTS / BEMERKUNGEN / REMARQUES
	W <sub>1</sub>	W <sub>2</sub>	D <sub>1</sub>	D <sub>2</sub>	H						
<b>LAV51L</b>	3202	3006	-	-	1105		410.0	3.741	27		

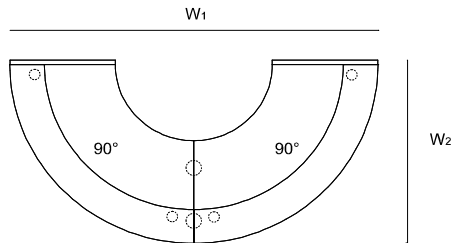
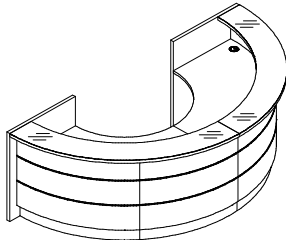

LAN1P+LAV90L+NL41+LAV90L+LAN2L

INDEX SYMBOL	DIMENSIONS / ABMESSUNGEN [mm]						⚖️	📦	📦		COMMENTS / BEMERKUNGEN / REMARQUES
	W <sub>1</sub>	W <sub>2</sub>	D <sub>1</sub>	D <sub>2</sub>	H						
<b>LAV52L</b>	3202	1639	-	-	1105		271.0	2.261	15		

DESCRIPTION / LEGENDE / LÉGENDE:

⚖️ net weight / Nettogewicht / poids net

📦 volume / Volumen / le volume

📦 number of packages / Stückzahl der Pakete / nombre de colis

**RECEPTION DESK SYSTEMS / EMPFANGSTHEKEN-SYSTEME / CONFIGURATIONS DES BANQUES**

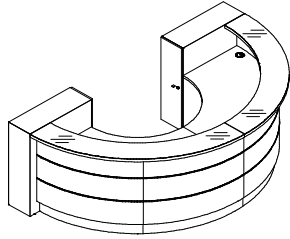

LAD10+LAP10+LAV90L+NL41+LAV90L+LAL10+LAD10

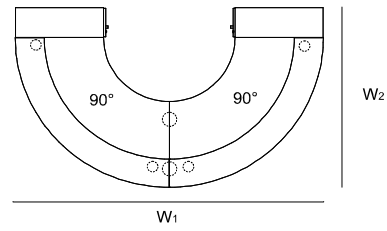

INDEX SYMBOL	DIMENSIONS / ABMESSUNGEN [mm]						⚖️	📦	📦		COMMENTS / BEMERKUNGEN / REMARQUES
	W <sub>1</sub>	W <sub>2</sub>	D <sub>1</sub>	D <sub>2</sub>	H						
<b>LAV61L</b>	3202	1919	-	-	1105		329.0	2.923	17		

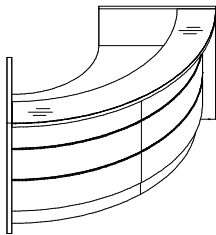

LAN1P+LAV90L+LAN2L

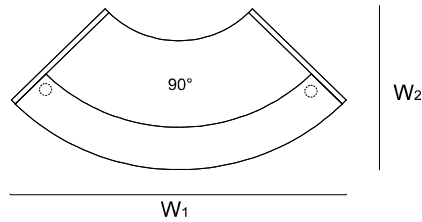

INDEX SYMBOL	DIMENSIONS / ABMESSUNGEN [mm]						⚖️	📦	📦		COMMENTS / BEMERKUNGEN / REMARQUES
	W <sub>1</sub>	W <sub>2</sub>	D <sub>1</sub>	D <sub>2</sub>	H						
<b>LAV53L</b>	2317	1145	-	-	1105		162.5	1.213	9		

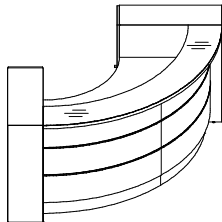

LAD10+LAP10+LAV90L+LAL10+LAD10

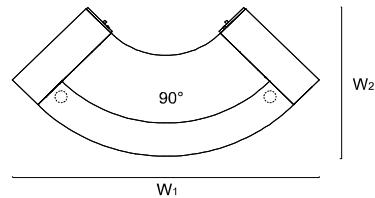

INDEX SYMBOL	DIMENSIONS / ABMESSUNGEN [mm]						⚖️	📦	📦		COMMENTS / BEMERKUNGEN / REMARQUES
	W <sub>1</sub>	W <sub>2</sub>	D <sub>1</sub>	D <sub>2</sub>	H						
<b>LAV73L</b>	2713	1353	-	-	1105		218.5	1.813	10		

DESCRIPTION / LEGENDE / LÉGENDE:

⚖️ net weight / Nettogewicht / poids net

📦 volume / Volumen / le volume

📦 number of packages / Stückzahl der Pakete / nombre de colis

**RECEPTION DESK SYSTEMS / EMPFANGSTHEKEN-SYSTEME / CONFIGURATIONS DES BANQUES**

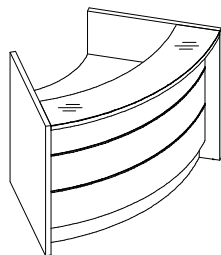

LAN1P+LAV64L+LAN2L

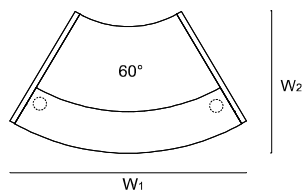

INDEX SYMBOL	DIMENSIONS / ABMESSUNGEN [mm]						⚖️	📦	📦		COMMENTS / BEMERKUNGEN / REMARQUES
	W <sub>1</sub>	W <sub>2</sub>	D <sub>1</sub>	D <sub>2</sub>	H						
<b>LAV54L</b>	1666	1029	-	-	1105		119.5	0.779	7		

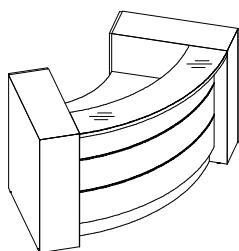

LAD10+LAP10+LAV64L+LAL10+LAD10

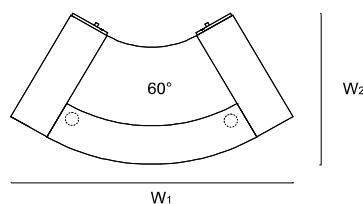

INDEX SYMBOL	DIMENSIONS / ABMESSUNGEN [mm]						⚖️	📦	📦		COMMENTS / BEMERKUNGEN / REMARQUES
	W <sub>1</sub>	W <sub>2</sub>	D <sub>1</sub>	D <sub>2</sub>	H						
<b>LAV74L</b>	2151	1183	-	-	1105		177.5	1.442	9		

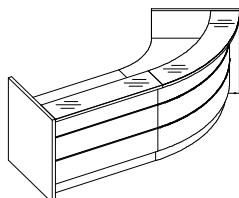

A: LAN1P+LA<sup>13</sup><sub>23L</sub>+NL41+LAV64L+LAN2L

B: LAN1P+LAV64L+NL41+LA<sup>13</sup><sub>23L</sub>+LAN2L

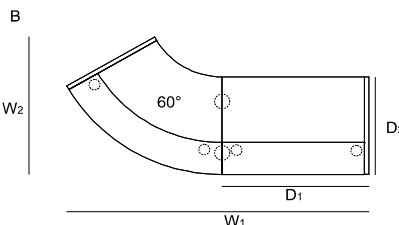
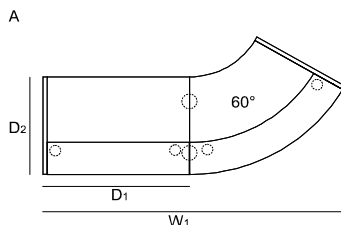

INDEX SYMBOL		DIMENSIONS / ABMESSUNGEN [mm]						⚖️	📦	📦		COMMENTS / BEMERKUNGEN / REMARQUES
A	B	W <sub>1</sub>	W <sub>2</sub>	D <sub>1</sub>	D <sub>2</sub>	H						
<b>LAV78L</b> <sup>13</sup>	<b>LAV79L</b> <sup>13</sup>	2733	1292	1328	917	1105		178.1	1.071	13		
<b>LAV80L</b> <sup>16</sup>	<b>LAV81L</b> <sup>16</sup>	3033	1292	1628	917	1105		191.5	1.118	13		
<b>LAV82L</b> <sup>23</sup>	<b>LAV83L</b> <sup>23</sup>	3733	1292	2318	917	1105		218.0	1.257	14		

DESCRIPTION / LEGENDE / LÉGENDE:

⚖️ net weight / Nettogewicht / poids net

📦 volume / Volumen / le volume

📦 number of packages / Stückzahl der Pakete / nombre de colis

**RECEPTION DESK SYSTEMS / EMPFANGSTHEKEN-SYSTEME / CONFIGURATIONS DES BANQUES**

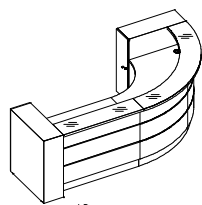

A: LAD10+LAP10+LA23L+NL41+LAV90L+LAL10+LAD10

B: LAD10+LAP10+LAV90L+NL41+LA23L+LAL10+LAD10

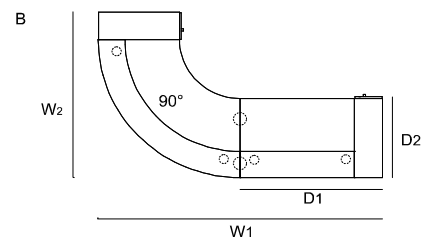
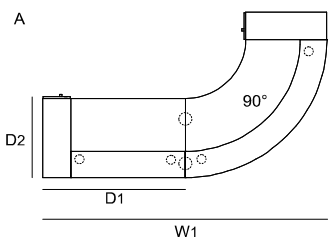

INDEX SYMBOL		DIMENSIONS / ABMESSUNGEN [mm]						kg	m3	pcs	COMMENTS / BEMERKUNGEN / REMARQUES
A	B	W <sub>1</sub>	W <sub>2</sub>	D <sub>1</sub>	D <sub>2</sub>	H					
LAV55L <sup>13</sup>	LAV56L <sup>13</sup>	3208	1918	1608	937	1105	277.1	2.104	16		
LAV57L <sup>16</sup>	LAV58L <sup>16</sup>	3508	1918	1908	937	1105	290.5	2.151	16		
LAV59L <sup>23</sup>	LAV60L <sup>23</sup>	4208	1918	2608	937	1105	317.0	2.291	17		

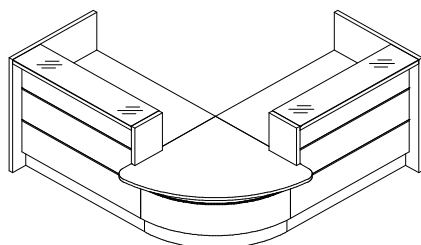

LAN1P+LA23L+NL41+LAN4L+LAV68L+NL41+LAN3P+LA23L+LAN2L

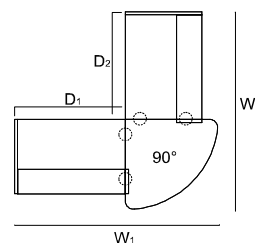

INDEX SYMBOL		DIMENSIONS / ABMESSUNGEN [mm]						kg	m3	pcs	COMMENTS / BEMERKUNGEN / REMARQUES
		W <sub>1</sub>	W <sub>2</sub>	D <sub>1</sub>	D <sub>2</sub>	H					
LAV101L <sup>13</sup>	LAV101L <sup>13</sup>	2437	2437	1328	1328	1105	207.3	0.955	18		
LAV102L <sup>13</sup>	LAV102L <sup>16</sup>	2437	2737	1328	1628	1105	220.7	1.002	18		
LAV103L <sup>13</sup>	LAV103L <sup>23</sup>	2437	3437	1328	2318	1105	247.2	1.141	19		
LAV104L <sup>16</sup>	LAV104L <sup>13</sup>	2737	2437	1628	1328	1105	220.7	1.002	18		
LAV105L <sup>16</sup>	LAV105L <sup>16</sup>	2737	2737	1628	1628	1105	234.1	1.049	18		
LAV106L <sup>16</sup>	LAV106L <sup>23</sup>	2737	3437	1628	2318	1105	260.6	1.189	19		
LAV107L <sup>23</sup>	LAV107L <sup>13</sup>	3437	2437	2318	1328	1105	247.2	1.141	19		
LAV108L <sup>23</sup>	LAV108L <sup>16</sup>	3437	2737	2318	1628	1105	260.6	1.189	19		
LAV109L <sup>23</sup>	LAV109L <sup>23</sup>	3437	3437	2318	2318	1105	285.6	1.311	19		

DESCRIPTION / LEGENDE / LÉGENDE:

net weight / Nettogewicht / poids net

volume / Volumen / le volume

number of packages / Stückzahl der Pakete / nombre de colis

## RECEPTION DESK SYSTEMS / EMPFANGSTHEKEN-SYSTEME / CONFIGURATIONS DES BANQUES

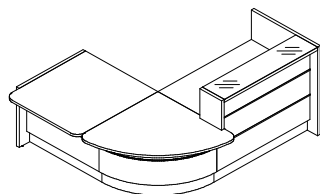

A: LAN5+LAU11L+NL41+LAV68L+NL41+LAN3+LA23L+LAN2<sup>13</sup>  
 B: LAN1+LA23L+NL41+LAN4+LAV68L+NL41+LAN11L+LAN6<sup>13</sup>

A

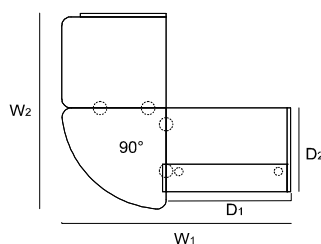

B

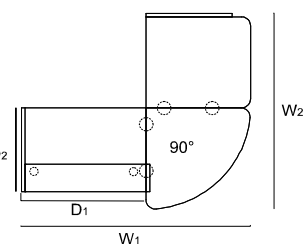

INDEX SYMBOL		DIMENSIONS / ABMESSUNGEN [mm]						kg	m <sup>3</sup>	pcs	COMMENTS / BEMERKUNGEN / REMARQUES
A	B	W <sub>1</sub>	W <sub>2</sub>	D <sub>1</sub>	D <sub>2</sub>	H					
LAV110L <sup>13</sup>	LAV111L <sup>13</sup>	2442	2147	1328	917	1105	176.4	0.832	16		
LAV112L <sup>16</sup>	LAV113L <sup>16</sup>	2742	2147	1628	917	1105	189.8	0.879	16		
LAV114L <sup>23</sup>	LAV115L <sup>23</sup>	3442	2147	2318	917	1105	216.3	1.019	17		

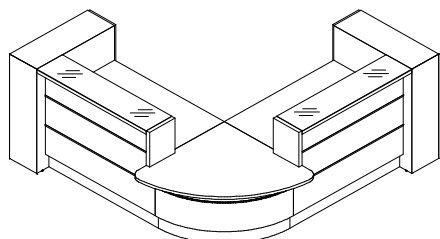

LAD10+LAP10+LA23L+NL41+LAN4L+LAV68L+NL41+LAN3P+LA23L+LAL10+LAD10<sup>13</sup>

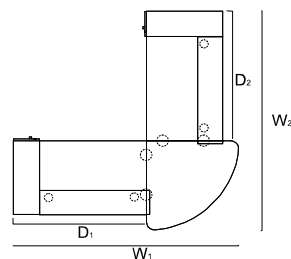

INDEX SYMBOL		DIMENSIONS / ABMESSUNGEN [mm]						kg	m <sup>3</sup>	pcs	COMMENTS / BEMERKUNGEN / REMARQUES
		W <sub>1</sub>	W <sub>2</sub>	D <sub>1</sub>	D <sub>2</sub>	H					
LAV116L <sup>13</sup>	LAV116L <sup>13</sup>	2717	2717	1608	1608	1105	265.3	1.617	20		
LAV117L <sup>13</sup>	LAV117L <sup>16</sup>	2717	3017	1608	1908	1105	278.7	1.664	20		
LAV118L <sup>13</sup>	LAV118L <sup>23</sup>	2717	3717	1608	2608	1105	305.2	1.804	21		
LAV119L <sup>16</sup>	LAV119L <sup>13</sup>	3017	2717	1908	1608	1105	278.7	1.664	20		
LAV120L <sup>16</sup>	LAV120L <sup>16</sup>	3017	3017	1908	1908	1105	292.1	1.711	20		
LAV121L <sup>16</sup>	LAV121L <sup>23</sup>	3017	3717	1908	2608	1105	318.6	1.851	21		
LAV122L <sup>23</sup>	LAV122L <sup>13</sup>	3717	2717	2608	1608	1105	305.2	1.804	21		
LAV123L <sup>23</sup>	LAV123L <sup>16</sup>	3717	3017	2608	1908	1105	318.6	1.851	21		
LAV124L <sup>23</sup>	LAV124L <sup>23</sup>	3717	3717	2608	2608	1105	343.6	1.973	21		

DESCRIPTION / LEGENDE / LÉGENDE:

net weight / Nettogewicht / poids net

volume / Volumen / le volume

number of packages / Stückzahl der Pakete / nombre de colis

**RECEPTION DESK SYSTEMS / EMPFANGSTHEKEN-SYSTEME / CONFIGURATIONS DES BANQUES**

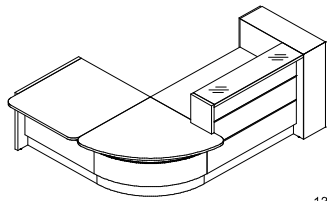

A

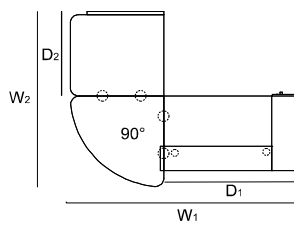

B

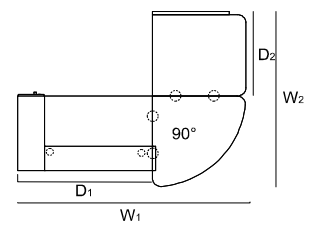

A: LAN5P+LAU11L+NL41+LAV68L+NL41+LAN3+LA23L+LAL10+LAD10

B: LAD10+LAP10+LA23L+NL41+LAN4L+LAV68L+NL41+LAU11L+LAN6L

INDEX SYMBOL		DIMENSIONS / ABMESSUNGEN [mm]						kg	m3	pcs	COMMENTS / BEMERKUNGEN / REMARQUES
A	B	W <sub>1</sub>	W <sub>2</sub>	D <sub>1</sub>	D <sub>2</sub>	H					
LAV125L <sup>13</sup>	LAV126L <sup>13</sup>	2722	2147	1608	1038	1105	210.4	1.181	18		
LAV127L <sup>16</sup>	LAV128L <sup>16</sup>	3022	2147	1908	1038	1105	214.8	1.204	17		
LAV129L <sup>23</sup>	LAV130L <sup>23</sup>	3722	2147	2608	1038	1105	245.3	1.350	18		

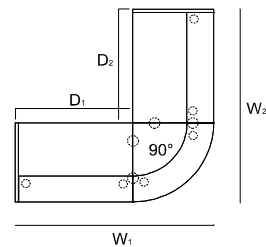
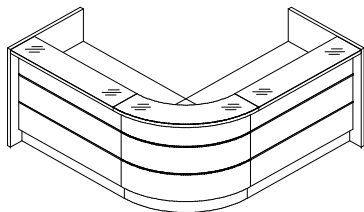

LAN1P+LA23L+NL41+LAV70L+NL41+LA23L+LAN2L

INDEX SYMBOL		DIMENSIONS / ABMESSUNGEN [mm]						kg	m3	pcs	COMMENTS / BEMERKUNGEN / REMARQUES
		W <sub>1</sub>	W <sub>2</sub>	D <sub>1</sub>	D <sub>2</sub>	H					
LAV131L <sup>13</sup>	LAV131L <sup>13</sup>	2245	2245	1328	1328	1105	209.7	1.041	17		
LAV132L <sup>13</sup>	LAV132L <sup>16</sup>	2245	2545	1328	1628	1105	223.1	1.088	17		
LAV133L <sup>13</sup>	LAV133L <sup>23</sup>	2245	3245	1328	2318	1105	249.6	1.228	18		
LAV134L <sup>16</sup>	LAV134L <sup>13</sup>	2545	2245	1628	1328	1105	223.1	1.088	17		
LAV135L <sup>16</sup>	LAV135L <sup>16</sup>	2545	2545	1628	1628	1105	236.5	1.136	17		
LAV136L <sup>16</sup>	LAV136L <sup>23</sup>	2545	3245	1628	2318	1105	263.0	1.275	18		
LAV137L <sup>23</sup>	LAV137L <sup>13</sup>	3245	2245	2318	1328	1105	249.6	1.228	18		
LAV138L <sup>23</sup>	LAV138L <sup>16</sup>	3245	2545	2318	1628	1105	263.0	1.275	18		
LAV139L <sup>23</sup>	LAV139L <sup>23</sup>	3245	3245	2318	2318	1105	288.0	1.397	18		

DESCRIPTION / LEGENDE / LÉGENDE:

net weight / Nettogewicht / poids net

volume / Volumen / le volume

number of packages / Stückzahl der Pakete / nombre de colis

**RECEPTION DESK SYSTEMS / EMPFANGSTHEKEN-SYSTEME / CONFIGURATIONS DES BANQUES**

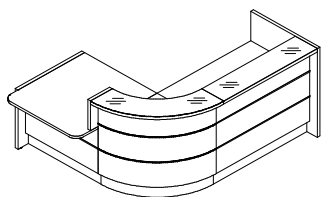

A: LAN5P+LAU11L+NL41+LAN3P+LAN70L+NL41+LA23L+LAN2L  
 B: LAN1P+LA23L+NL41+LAV70L+NL41+LAN4L+LAU11L+LAN6L

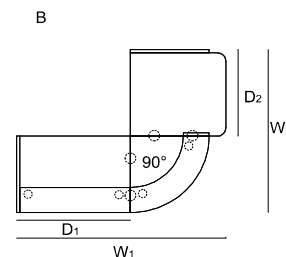
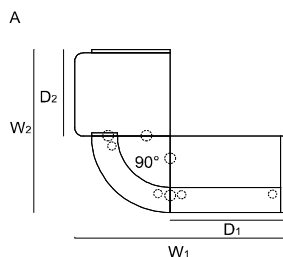

INDEX SYMBOL		DIMENSIONS / ABMESSUNGEN [mm]						kg	m3	pcs	COMMENTS / BEMERKUNGEN / REMARQUES
A	B	W <sub>1</sub>	W <sub>2</sub>	D <sub>1</sub>	D <sub>2</sub>	H					
LAV140L <sup>13</sup>	LAV141L <sup>13</sup>	2442	1955	1328	1038	1105	184.4	0.933	17		
LAV142L <sup>16</sup>	LAV143L <sup>16</sup>	2742	1955	1628	1038	1105	197.8	0.980	17		
LAV144L <sup>23</sup>	LAV145L <sup>23</sup>	3442	1955	2318	1038	1105	224.3	1.119	18		

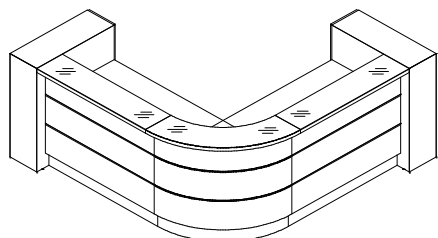

LAD10+LAP10+LA23L+NL41+LAV70L+NL41+LA23L+LAL10+LAD10

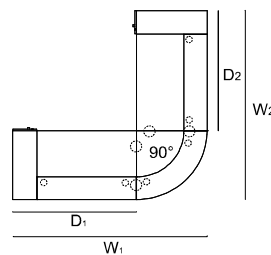

INDEX SYMBOL		DIMENSIONS / ABMESSUNGEN [mm]						kg	m3	pcs	COMMENTS / BEMERKUNGEN / REMARQUES
		W <sub>1</sub>	W <sub>2</sub>	D <sub>1</sub>	D <sub>2</sub>	H					
LAV146L <sup>13</sup>	LAV146L <sup>13</sup>	2525	2525	1608	1608	1105	267.7	1.704	19		
LAV147L <sup>13</sup>	LAV147L <sup>16</sup>	2525	2825	1608	1908	1105	281.1	1.751	19		
LAV148L <sup>13</sup>	LAV148L <sup>23</sup>	2525	3525	1608	2608	1105	307.6	1.890	20		
LAV149L <sup>16</sup>	LAV149L <sup>13</sup>	2825	2525	1908	1608	1105	281.1	1.751	19		
LAV150L <sup>16</sup>	LAV150L <sup>16</sup>	2825	2825	1908	1908	1105	294.5	1.798	19		
LAV151L <sup>16</sup>	LAV151L <sup>23</sup>	2825	3525	1908	2608	1105	321.0	1.937	20		
LAV152L <sup>23</sup>	LAV152L <sup>13</sup>	3525	2525	2608	1608	1105	307.6	1.890	20		
LAV153L <sup>23</sup>	LAV153L <sup>16</sup>	2525	2825	2608	1908	1105	321.0	1.937	20		
LAV154L <sup>23</sup>	LAV154L <sup>23</sup>	3525	3525	2608	2608	1105	346.0	2.060	20		

DESCRIPTION / LEGENDE / LÉGENDE:

net weight / Nettogewicht / poids net

volume / Volumen / le volume

number of packages / Stückzahl der Pakete / nombre de colis

**RECEPTION DESK SYSTEMS / EMPFANGSTHEKEN-SYSTEME / CONFIGURATIONS DES BANQUES**

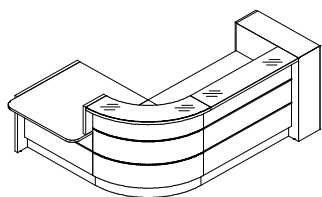

A:

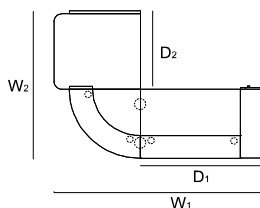

B:

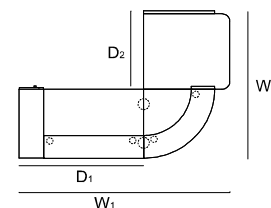

A: LAN5P+LAU11L+NL41+LAN3P+LWC70L+NL41+LW23L+LWL10+LWD10

B: LWD10+LWP10+LW23L+NL41+LWC70L+NL41+LWN4L+LWU11L+LWN6L

INDEX SYMBOL		DIMENSIONS / ABMESSUNGEN [mm]						kg	m3	pcs	COMMENTS / BEMERKUNGEN / REMARQUES
A	B	W <sub>1</sub>	W <sub>2</sub>	D <sub>1</sub>	D <sub>2</sub>	H					
LAV155L <sup>13</sup>	LAV156L <sup>13</sup>	2722	1955	1608	1038	1105	218.4	1.282	19		
LAV157L <sup>16</sup>	LAV158L <sup>16</sup>	3022	1955	1908	1038	1105	222.8	1.305	18		
LAV159L <sup>23</sup>	LAV160L <sup>23</sup>	3722	1955	2608	1038	1105	253.3	1.451	19		

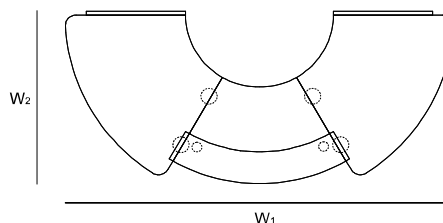
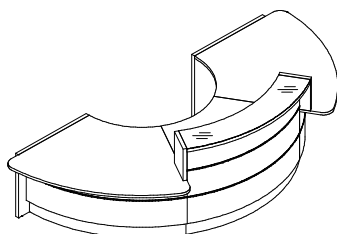

LAN5P+LAV66L+LAN3P+NL41+LAV64L+LAN4L+NL41+LAV66L+LAN6L

INDEX SYMBOL		DIMENSIONS / ABMESSUNGEN [mm]						kg	m3	pcs	COMMENTS / BEMERKUNGEN / REMARQUES
A	B	W <sub>1</sub>	W <sub>2</sub>	D <sub>1</sub>	D <sub>2</sub>	H					
LAV05L		3589	1629	-	-	1105	224.1	1.781	17		

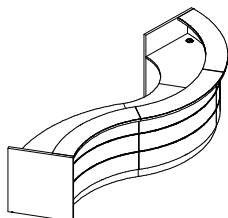

A:

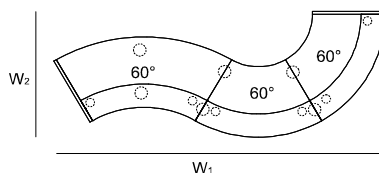

B:

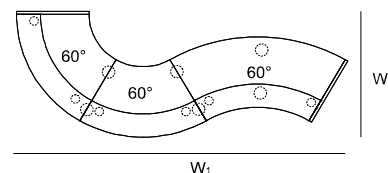

A: LAN1P+LAV62L+NL41+LAV64L+NL41+LAV64L+LAN2L

B: LAN1P+LAV64L+NL41+LAV64L+NL41+LAV62L+LAN2L

INDEX SYMBOL		DIMENSIONS / ABMESSUNGEN [mm]						kg	m3	pcs	COMMENTS / BEMERKUNGEN / REMARQUES
A	B	W <sub>1</sub>	W <sub>2</sub>	D <sub>1</sub>	D <sub>2</sub>	H					
LAV06L	LAV07L	4199	1629	-	-	1105	269.5	2.345	20		

DESCRIPTION / LEGENDE / LÉGENDE:

net weight / Nettogewicht / poids net

volume / Volumen / le volume

number of packages / Stückzahl der Pakete / nombre de colis



**RECEPTION DESK SYSTEMS / EMPFANGSTHEKEN-SYSTEME / CONFIGURATIONS DES BANQUES**

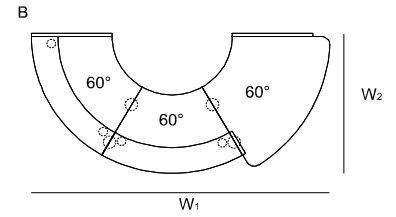
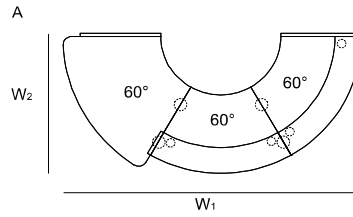
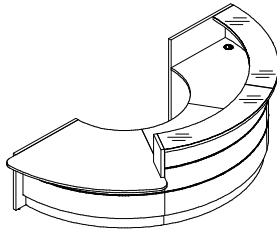

A: LAN5P+LAV66L+NL41+LAN3P+LAV64L+NL41+LAV64L+LAN2L  
 B: LAN1P+LAV64L+NL41+LAV64L+NL41+LAN4L+LAV66L+LAN6L



INDEX SYMBOL		DIMENSIONS / ABMESSUNGEN [mm]						⚖️	📦	📦		COMMENTS / BEMERKUNGEN / REMARQUES
A	B	W <sub>1</sub>	W <sub>2</sub>	D <sub>1</sub>	D <sub>2</sub>	H						
<b>LAV08L</b>	<b>LAV09L</b>	3367	1629	-	-	1105	235.3	2.009	16			

DESCRIPTION / LEGENDE / LÉGENDE:







⚖️ net weight / Nettogewicht / poids net

📦 volume / Volumen / le volume

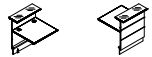
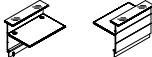
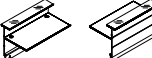
📦 number of packages / Stückzahl der Pakete / nombre de colis

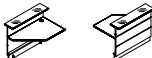
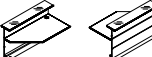
PRODUCT ILLUSTRATION / PRODUKTANSICHT UND SKIZZE / VUE DE PRODUIT	DIMENSIONS / ABMESSUNGEN [mm]			INDEX SYMBOL						COMMENTS / BEMERKUNGEN / REMARQUES
	WIDTH / BREITE / LARGEUR	DEPTH / TIEFE / PROFONDEUR	HEIGHT / HÖHE / HAUTEUR			kg	m3	pcs		

**STRAIGHT ELEMENTS / GERADE BAUTEILE / ÉLÉMENTS COMPOSANTS SIMPLES**

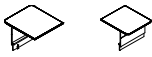

	844	917	1105	<b>LA09L</b>		37.0	0.153	6		
	1290	917	1105	<b>LA13L</b>		57.6	0.233	7		
	1590	917	1105	<b>LA16L</b>		71.0	0.280	7		
	2290	917	1105	<b>LA23L</b>		97.5	0.419	8		
	1290	917	1105	<b>LAP13L</b>		56.6	0.233	7		
	1590	917	1105	<b>LAP16L</b>		70.5	0.280	7		
	2290	917	1105	<b>LAP23L</b>		97.0	0.419	8		Worktop with NE41 / Arbeitsplatte mit NE41 / Plan de travail avec NE41
	1290	917	1105	<b>LAL13L</b>		56.6	0.233	7		
	1590	917	1105	<b>LAL16L</b>		70.5	0.280	7		
	2290	917	1105	<b>LAL23L</b>		97.0	0.419	8		
	1000	1114	740	<b>LAU11L</b>		33.5	0.128	5		

DESCRIPTION / LEGENDE / LÉGENDE:





 net weight / Nettogewicht / poids net

 volume / Volumen / le volume

 number of packages / Stückzahl der Pakete / nombre de colis

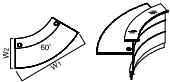
PRODUCT ILLUSTRATION / PRODUKTANSICHT UND SKIZZE / VUE DE PRODUIT	DIMENSIONS / ABMESSUNGEN [mm]			INDEX SYMBOL						COMMENTS / BEMERKUNGEN / REMARQUES
	WIDTH / BREITE / LARGEUR	DEPTH / TIEFE / PROFONDEUR	HEIGHT / HÖHE / HAUTEUR			kg	m3	pcs		

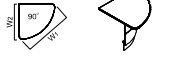
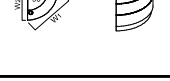
**RADIAL ELEMENTS / BAUTEILE - BOGENELEMENTE / ÉLÉMENTS COMPOSANTS D ANGLE**



	2216	917	1105	LAV62L		79.5	0.767	8		
	1600	917	1105	LAV64L		68.5	0.681	7		
	1720	1109	740	LAV66L		54.5	0.446	3		
	1485	1109	740	LAV68L		35.5	0.260	3		
	1297	917	1105	LAV70L		43.5	0.361	4		
	2264	917	1105	LAV90L		137.5	1.128	9		
	1225	917	1105	LAV63L		54.5	0.506	6		

DESCRIPTION / LEGENDE / LÉGENDE:

 net weight / Nettogewicht / poids net

 volume / Volumen / le volume

 number of packages / Stückzahl der Pakete / nombre de colis

PRODUCT ILLUSTRATION / PRODUKTANSICHT UND SKIZZE / VUE DE PRODUIT	DIMENSIONS / ABMESSUNGEN [mm]			INDEX SYMBOL		 kg	 m3	 pcs		COMMENTS / BEMERKUNGEN / REMARQUES
	WIDTH / BREITE / LARGEUR	DEPTH / TIEFE / PROFONDEUR	HEIGHT / HÖHE / HAUTEUR							

**ELEMENTS / BAUTEILE / ÉLÉMENTS COMPOSANTS**

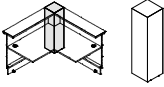
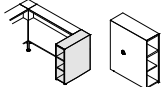
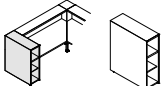
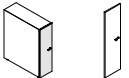
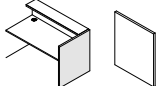
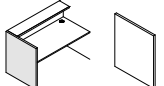
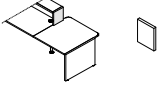
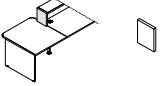

	300	300	1105	<b>LA100</b>		22.2	0.115	1		- corner unit / - Würfel Fuß / - monobloc fermé
	318	917	1105	<b>LAP10</b>		50.0	0.364	1		- end unit with cupboard, right, only for high units ! / - Seitenschrank, Recht, nur für hohe Empfangstheken ! / - monobloc à étagères, droit, seulement pour éléments hauts !
	318	917	1105	<b>LAL10</b>		50.0	0.364	1		- end unit with cupboard, left, only for high units ! / - Seitenschrank, Links, nur für hohe Empfangstheken ! / - monobloc à étagères, gauche, seulement pour éléments hauts !
	306	20	1088	<b>LAD10</b>		5.0	0.018	1		- door for LWP10and LWL10 / - Tür mit Verschlusszum LWP10,LWL10 / - porte pour LWP10et LWL10
	38	917	1105	<b>LAN1P</b>		26.0	0.051	1		side panel for highunits, right / - Wangenfuß, Recht / - pied coté droit deséléments hauts
	38	917	1105	<b>LAN2L</b>		26.0	0.051	1		- side panel for highunits, left / - Wangenfuß, Links / - pied coté gauchedes éléments hauts
	38	300	364	<b>LAN3P</b>		2.8	0.007	1		- right upper sidepanel / - Endungselent,Recht / - élément de finitionde la rehausse,droit
	38	300	364	<b>LAN4L</b>		2.8	0.007	1		- left upper sidepanel / - Endungselent,Links / - élément de finitionde la rehausse,gauche

DESCRIPTION / LEGENDE / LÉGENDE:







 net weight / Nettogewicht / poids net

 volume / Volumen / le volume

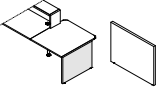
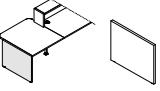
 number of packages / Stückzahl der Pakete / nombre de colis

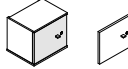
PRODUCT ILLUSTRATION / PRODUKTANSICHT UND SKIZZE / VUE DE PRODUIT	DIMENSIONS / ABMESSUNGEN [mm]			INDEX SYMBOL						COMMENTS / BEMERKUNGEN / REMARQUES
	WIDTH / BREITE / LARGEUR	DEPTH / TIEFE / PROFONDEUR	HEIGHT / HÖHE / HAUTEUR							

**ELEMENTS / BAUTEILE / ÉLÉMENTS COMPOSANTS**

	38	917	740	<b>LAN5P</b>		19.0	0.036	1		- right lower sidepanel / - Wangenfuß niedrig,Recht / - pied de la banquettepour leshandicapésés,dront
	38	917	740	<b>LAN6L</b>		19.0	0.036	1		- left lower side panel / - Wangenfuß niedrig,Links / - pied de la banquettepour leshandicapésés,gauche
	345	283	314	<b>LMS05</b>		5.0	0.031	1		
	339	18	286	<b>LMS06</b>		2.0	0.005	1		
	585	142	690	<b>NL41</b>		2.0	0.063	1		
	40	40	712	<b>NE41</b>		1.5	0.017	1		straight leg / Rundfuß / pied tube
	140	70	750	<b>S81</b>		1.1	0.008	1		- vertical cable ductin colour 09-aluminium / Kabelführung (Wirbelsäule) Farbe 09 - Aluminium / passe-cables colonne verticale
	460	70	87	<b>E64</b>		0.0	0.000	0		horizontal cable tray 09-aluminium / Kabelkanal 09 - Aluminium / bac à câble - 09 aluminium

DESCRIPTION / LEGENDE / LÉGENDE:

 net weight / Nettogewicht / poids net

 volume / Volumen / le volume

 number of packages / Stückzahl der Pakete / nombre de colis