

TECHNICAL SPECIFICATION / TECHNISCHE BESCHREIBUNG / DESCRIPTION TECHNIQUE
**Glass top
Glasplatte
Top verre**

OPTIWHITE Glass painted on the underside
Glas OPTIWHITE von unten bemalt
Verre OPTIWHITE laque d'en-dessous
8mm

Front / Front / Façade

Powder-coated metal
element with plexiglass
Metall pulverbeschichtet , Plexiglas
Éléments en plexiglass dans l'habillage
en acier peint en poudre

**Illumination
Beleuchtung
Illumination**

RGBW LED

**Worktop
Arbeitsplatte
Plan de travail**

MFC / Melaminplatte /
Panneau mélaminé
28mm

**Lower side panel
Wangenfuß niedrig
Pied bas**

MFC / Melaminplatte /
Panneau mélaminé
28mm

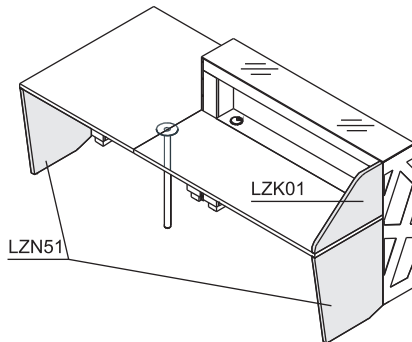
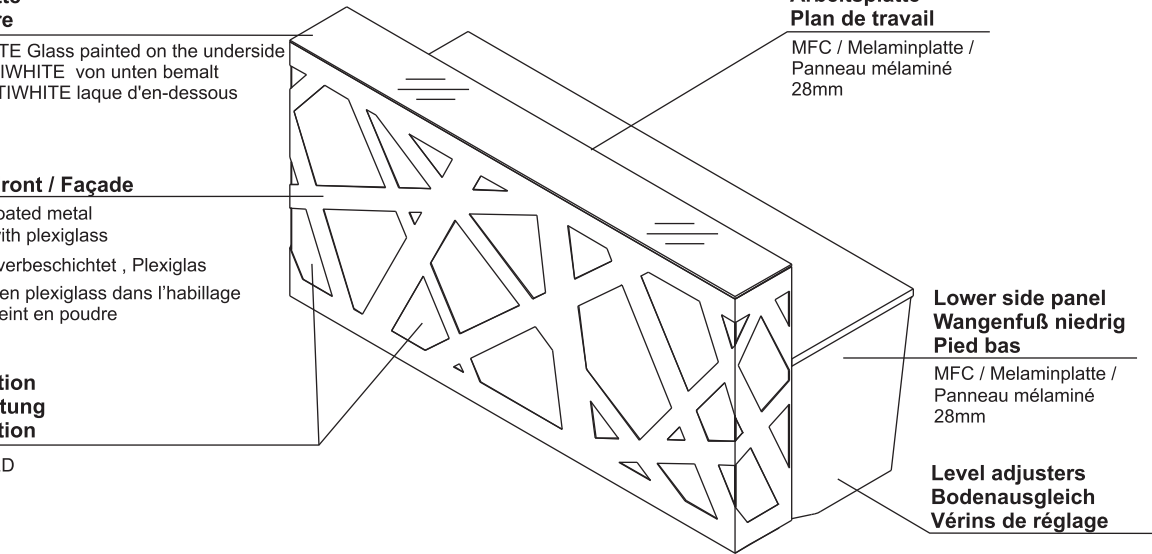
**Level adjusters
Bodenausgleich
Vérins de réglage**

**Cable-way
Kabeldurchlass
Obturateur**
 Ø 80mm

**Supporting leg where worktops connect
Stützfuß
Nécessaire sur la jonction des banquettes**

NE41 required on all connections of receptions /
NE41 Stützfuß zusätzlich zur Verbindung der
Thekenelemente bestellen /
NE41 nécessaire sur la connexion des banquettes
15 - METAL, HIGH GLOSS WHITE
15 - METALL, WEIß GLANZ
15 - METAL, BLANC BRILLANT

**Upper side panel
Endungselement
Panneau latéral**

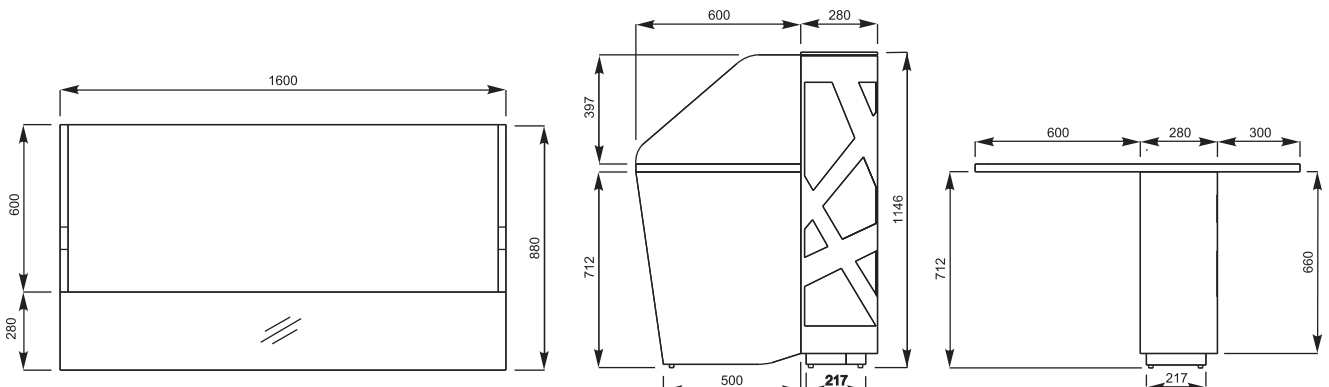
MFC / Melaminplatte /
Panneau mélaminé
28mm

DIMENSIONS / ABMESSUNGEN / DIMENSIONS

FINISHES / FARBEN / FINITIONS

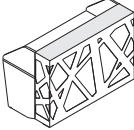
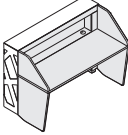
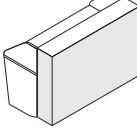
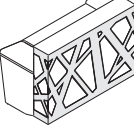
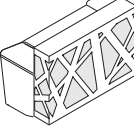
TEMPERED GLASS, WHITE HARTGLAS, WEIß VERRE TREMPÉ, BLANC		
67 WHITE PASTEL WEIß PASTELL BLANC PASTEL		
15 WHITE METAL WEIß METAL BLANC		
PLEXIGLASS WHITE PLEXIGLAS WEIß PLEXIGLASS BLANC		

RECEPTION DESK SYSTEMS / EMPFANGSTHEKEN-SYSTEME / CONFIGURATIONS DES BANQUES

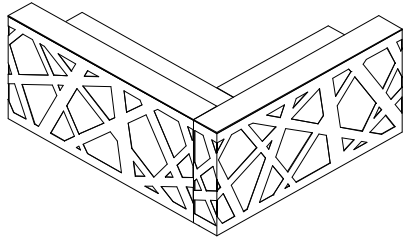

LZN51+LZG22+LZB22+NE41+LZG22+LZB22M

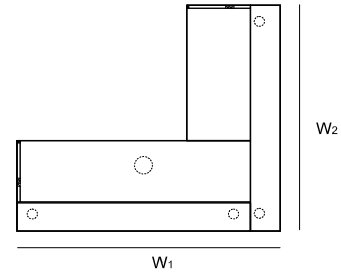

INDEX SYMBOL	DIMENSIONS / ABMESSUNGEN [mm]						⚖️	📦	📦		COMMENTS / BEMERKUNGEN / REMARQUES
	W ₁	W ₂	D ₁	D ₂	H						
LZG44	2480	2200	-	-	1146		293.7	3.186	18		

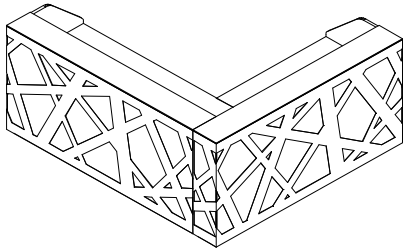

LZK01+LZN51+LZG22+LZB22+NE41+LZG22+LZB22M

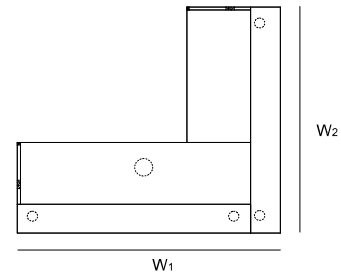

INDEX SYMBOL	DIMENSIONS / ABMESSUNGEN [mm]						⚖️	📦	📦		COMMENTS / BEMERKUNGEN / REMARQUES
	W ₁	W ₂	D ₁	D ₂	H						
LZG45	2480	2200	-	-	1146		300.7	3.206	19		

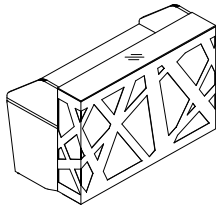

LZ034 - LZK01+LZN51+LZG16+LZB16
LZ046 - LZK01+LZN51+LZG22+LZB22+NE41

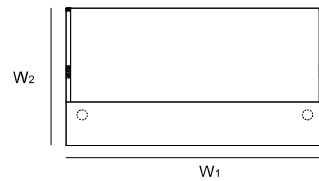

INDEX SYMBOL	DIMENSIONS / ABMESSUNGEN [mm]						⚖️	📦	📦		COMMENTS / BEMERKUNGEN / REMARQUES
	W ₁	W ₂	D ₁	D ₂	H						
LZG34	1600	880	-	-	1146		131.9	1.250	9		
LZG46	2200	880	-	-	1146		165.4	1.648	10		

DESCRIPTION / LEGENDE / LÉGENDE:

⚖️ net weight / Nettogewicht / poids net

📦 volume / Volumen / le volume

📦 number of packages / Stückzahl der Pakete / nombre de colis

RECEPTION DESK SYSTEMS / EMPFANGSTHEKEN-SYSTEME / CONFIGURATIONS DES BANQUES

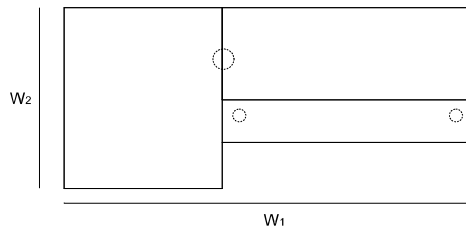
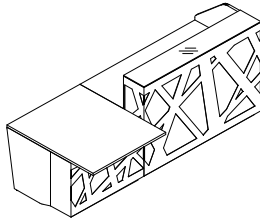

1xNE41 16 16
LZN51+LZG10+2xNE41+LZG22+LZB22+LZK01

INDEX SYMBOL	DIMENSIONS / ABMESSUNGEN [mm]						⚖️	📦	📦		COMMENTS / BEMERKUNGEN / REMARQUES
	W ₁	W ₂	D ₁	D ₂	H						
LZG50	2600	1180	-	-	1146		218.4	1.822	15		
LZG51	3200	1180	-	-	1146		250.4	2.203	15		

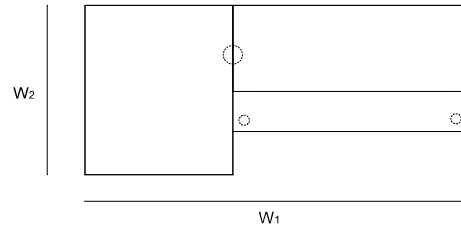
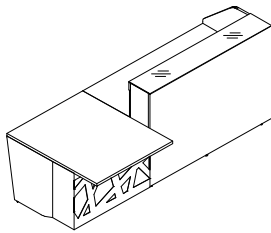

LZB16+LZG16M+LZG10+LZN51+LZK01+NE41

INDEX SYMBOL	DIMENSIONS / ABMESSUNGEN [mm]						⚖️	📦	📦		COMMENTS / BEMERKUNGEN / REMARQUES
	W ₁	W ₂	D ₁	D ₂	H						
LZG56	2600	1180	-	-	1146		220.4	1.822	15		

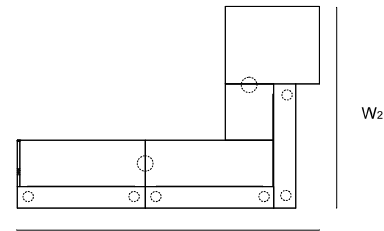
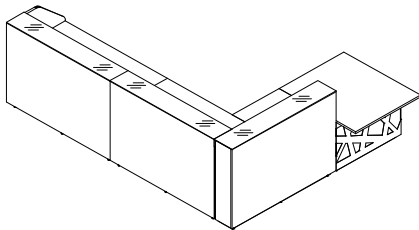

3xLZG16M+LZG10+LZK01+LZN51+LZB16M+2xLZB16+3xNE41

INDEX SYMBOL	DIMENSIONS / ABMESSUNGEN [mm]						⚖️	📦	📦		COMMENTS / BEMERKUNGEN / REMARQUES
	W ₁	W ₂	D ₁	D ₂	H						
LZG57	3200	2880	-	-	1146		439.2	4.215	31		

DESCRIPTION / LEGENDE / LÉGENDE:

⚖️ net weight / Nettogewicht / poids net

📦 volume / Volumen / le volume

📦 number of packages / Stückzahl der Pakete / nombre de colis

RECEPTION DESK SYSTEMS / EMPFANGSTHEKEN-SYSTEME / CONFIGURATIONS DES BANQUES

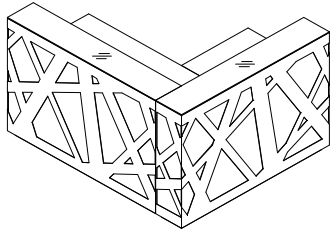

LZN51+LZG16W+LZB16+LZG16+LZB16M

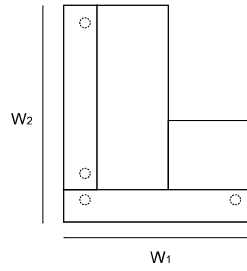

INDEX SYMBOL	DIMENSIONS / ABMESSUNGEN [mm]						⚖️	📦	📦		COMMENTS / BEMERKUNGEN / REMARQUES
	W ₁	W ₂	D ₁	D ₂	H						
LZG32	1600	1880	-	-	1146		227.5	2.395	16		

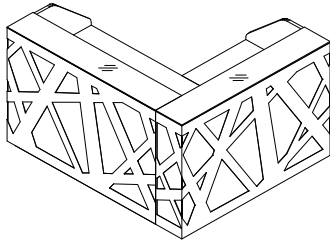

LZK01+LZN51+LZG16+LZB16+LZG16+LZB16M

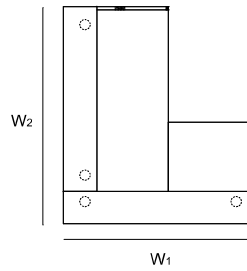

INDEX SYMBOL	DIMENSIONS / ABMESSUNGEN [mm]						⚖️	📦	📦		COMMENTS / BEMERKUNGEN / REMARQUES
	W ₁	W ₂	D ₁	D ₂	H						
LZG35	1600	1880	-	-	1146		234.5	2.414	17		

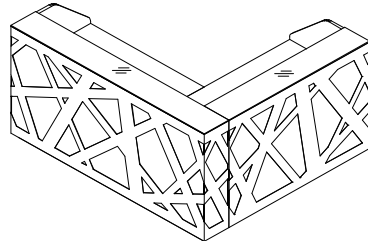

LZK01+LZN51+LZG22+LZB22M+LZG16+LZB16

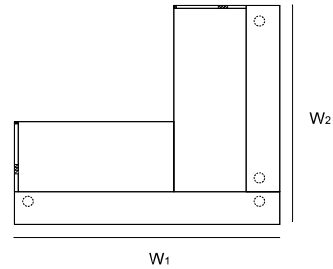

INDEX SYMBOL	DIMENSIONS / ABMESSUNGEN [mm]						⚖️	📦	📦		COMMENTS / BEMERKUNGEN / REMARQUES
	W ₁	W ₂	D ₁	D ₂	H						
LZG36	2200	1880	-	-	1146		266.5	2.807	17		

DESCRIPTION / LEGENDE / LÉGENDE:

⚖️ net weight / Nettogewicht / poids net

📦 volume / Volumen / le volume

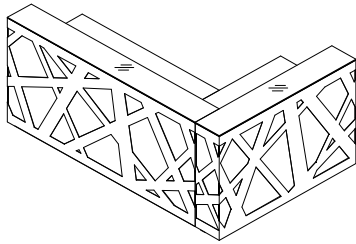

📦 number of packages / Stückzahl der Pakete / nombre de colis

RECEPTION DESK SYSTEMS / EMPFANGSTHEKEN-SYSTEME / CONFIGURATIONS DES BANQUES

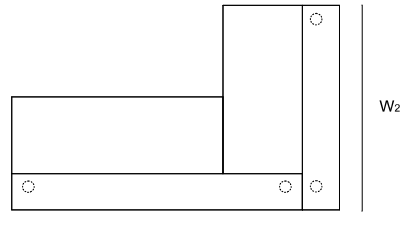
LZN51+LZG22+LZB16+LZG16+LZB22M



W1

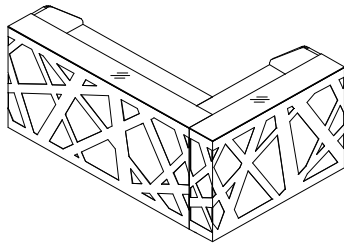

INDEX SYMBOL	DIMENSIONS / ABMESSUNGEN [mm]									COMMENTS / BEMERKUNGEN / REMARQUES
	W ₁	W ₂	D ₁	D ₂	H		kg	m ³	pcs	
LZG38	2480	1600	-	-	1146		259.5	2.788	16	

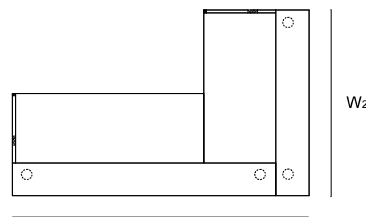

LZK01+LZN51+LZG22+LZB16+LZG16+LZB22M



W1

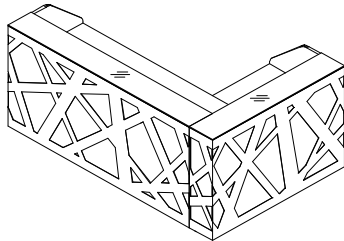

INDEX SYMBOL	DIMENSIONS / ABMESSUNGEN [mm]									COMMENTS / BEMERKUNGEN / REMARQUES
	W ₁	W ₂	D ₁	D ₂	H		kg	m ³	pcs	
LZG40	2480	1600	-	-	1146		266.5	2.807	17	

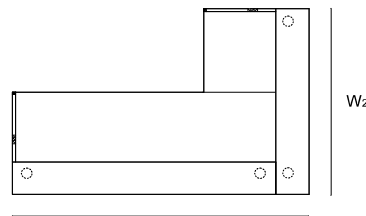

LZK01+LZN51+LZG22+LZB22+NE41+LZG16+LZB16M



W1

INDEX SYMBOL	DIMENSIONS / ABMESSUNGEN [mm]									COMMENTS / BEMERKUNGEN / REMARQUES
	W ₁	W ₂	D ₁	D ₂	H		kg	m ³	pcs	
LZG42	2480	1600	-	-	1146		265.9	2.811	15	

DESCRIPTION / LEGENDE / LÉGENDE:

 net weight / Nettogewicht / poids net

 volume / Volumen / le volume

 number of packages / Stückzahl der Pakete / nombre de colis

RECEPTION DESK SYSTEMS / EMPFANGSTHEKEN-SYSTEME / CONFIGURATIONS DES BANQUES

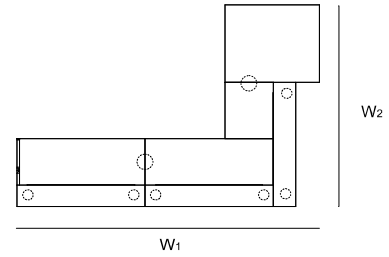
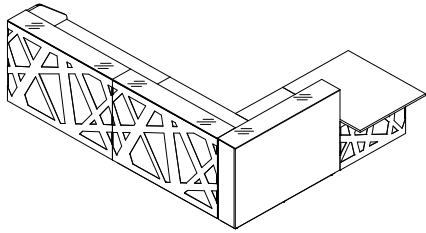

LZG16M+2xLZG16+LZG10+LZK01+LZN51+LZB16M+2xLZB16+3xNE41

INDEX SYMBOL	DIMENSIONS / ABMESSUNGEN [mm]						⚖️	📦	📦		COMMENTS / BEMERKUNGEN / REMARQUES
	W ₁	W ₂	D ₁	D ₂	H						
LZG58	3808	2880	-	-	1146		435.2	4.215	31		

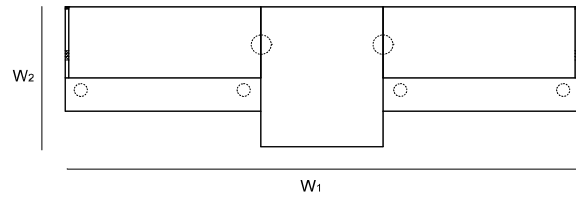
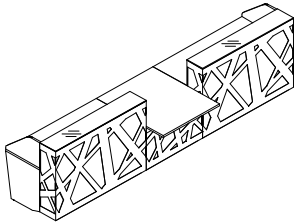

¹⁶ 16 2xNE41 ¹⁶ 16
¹⁶ 16 3xNE41 ²² 22
LZN51+LZG22+LZB22+4xNE41+LZG10+LZG22+LZB22+LZK01

INDEX SYMBOL	DIMENSIONS / ABMESSUNGEN [mm]						⚖️	📦	📦		COMMENTS / BEMERKUNGEN / REMARQUES
	W ₁	W ₂	D ₁	D ₂	H						
LZG52	4200	1180	-	-	1146		329.8	3.034	23		
LZG53	4800	1180	-	-	1146		363.3	3.433	24		
LZG54	5400	1180	-	-	1146		396.8	3.831	25		

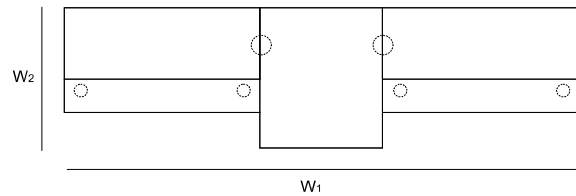
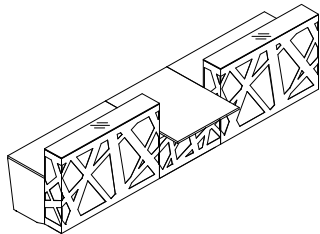

LZN51+LZG16+LZB16+NE41+LZG10+NE41+LZG16+LZB16

INDEX SYMBOL	DIMENSIONS / ABMESSUNGEN [mm]						⚖️	📦	📦		COMMENTS / BEMERKUNGEN / REMARQUES
	W ₁	W ₂	D ₁	D ₂	H						
LZG55	4200	1180	-	-	1146		322.8	3.015	22		

DESCRIPTION / LEGENDE / LÉGENDE:

⚖️ net weight / Nettogewicht / poids net

📦 volume / Volumen / le volume

📦 number of packages / Stückzahl der Pakete / nombre de colis

RECEPTION DESK SYSTEMS / EMPFANGSTHEKEN-SYSTEME / CONFIGURATIONS DES BANQUES

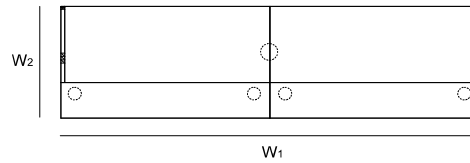
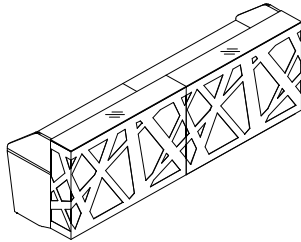

16 16 1xNE41 16 16
16 16 2xNE41 22 22
LZK01+LZN51+LZG22+LZB22+3xNE41+LZG22+LZB22

INDEX SYMBOL	DIMENSIONS / ABMESSUNGEN [mm]						⚖️	📦	📦		COMMENTS / BEMERKUNGEN / REMARQUES
	W ₁	W ₂	D ₁	D ₂	H						
LZG60	3200	880	-	-	1146		243.3	2.462	17		
LZG61	3800	880	-	-	1146		276.8	2.860	18		
LZG62	4400	880	-	-	1146		310.3	3.258	19		

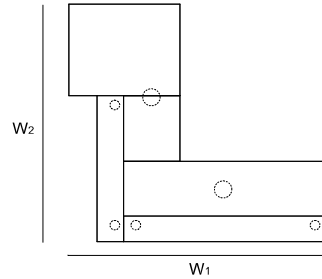
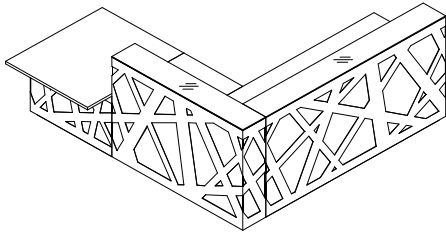

LZN51+LZG10+NE41+LZG16+LZB16M+LZG22+LZB22+NE41

INDEX SYMBOL	DIMENSIONS / ABMESSUNGEN [mm]						⚖️	📦	📦		COMMENTS / BEMERKUNGEN / REMARQUES
	W ₁	W ₂	D ₁	D ₂	H						
LZG64	2600	2780	-	-	1146		346.8	3.365	22		

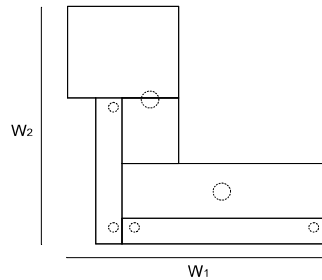
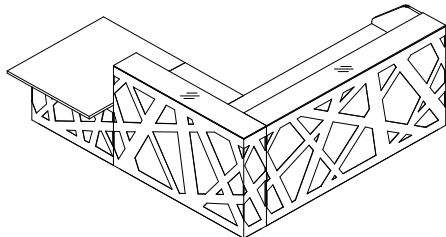

LZN51+LZG10+NE41+LZG16+LZB16M+LZG22+LZB22+NE41+LZK01



INDEX SYMBOL	DIMENSIONS / ABMESSUNGEN [mm]						⚖️	📦	📦		COMMENTS / BEMERKUNGEN / REMARQUES
	W ₁	W ₂	D ₁	D ₂	H						
LZG63	2600	2780	-	-	1146		353.8	3.384	23		

DESCRIPTION / LEGENDE / LÉGENDE:









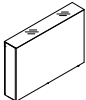

⚖️ net weight / Nettogewicht / poids net

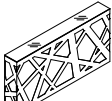
📦 volume / Volumen / le volume

📦 number of packages / Stückzahl der Pakete / nombre de colis

PRODUCT ILLUSTRATION / PRODUKTANSICHT UND SKIZZE / VUE DE PRODUIT	DIMENSIONS / ABMESSUNGEN [mm]			INDEX SYMBOL						COMMENTS / BEMERKUNGEN / REMARQUES
	WIDTH / BREITE / LARGEUR	DEPTH / TIEFE / PROFONDEUR	HEIGHT / HÖHE / HAUTEUR			kg	m3	pcs		

ELEMENTS / BAUTEILE / ÉLÉMENTS COMPOSANTS



	1600	280	1146	LZG16M		93.5	1.147	4		
	1600	280	1146	LZG16		91.5	1.147	4		
	2200	280	1146	LZG22		116.5	1.527	4		
	1000	1180	740	LZG10		85.0	0.555	5		
	720	600	28	LZB16M		10.4	0.017	3		
	1320	600	28	LZB22M		18.1	0.031	4		
	1600	600	28	LZB16		18.4	0.049	3		
	2200	600	28	LZB22		25.4	0.050	3		
	600	28	397	LZK01		7.0	0.020	1		
	600	28	712	LZN51		15.0	0.035	1		
	40	40	712	NE41		1.5	0.017	1		straight leg / Rundfuß / pied tube

DESCRIPTION / LEGENDE / LÉGENDE:

 net weight / Nettogewicht / poids net

 volume / Volumen / le volume

 number of packages / Stückzahl der Pakete / nombre de colis

PRODUCT ILLUSTRATION / PRODUKTANSICHT UND SKIZZE / VUE DE PRODUIT	DIMENSIONS / ABMESSUNGEN [mm]			INDEX SYMBOL						COMMENTS / BEMERKUNGEN / REMARQUES
	WIDTH / BREITE / LARGEUR	DEPTH / TIEFE / PROFONDEUR	HEIGHT / HÖHE / HAUTEUR			kg	m3	pcs		

ELEMENTS / BAUTEILE / ÉLÉMENTS COMPOSANTS

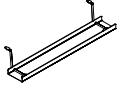
	460	70	87	E64		0.0	0.000	0		horizontal cable tray 09-aluminum / Kabelkanal 09 - Aluminium / bac à câble - 09 aluminium
---	-----	----	----	------------	--	-----	-------	---	--	--

DESCRIPTION / LEGENDE / LÉGENDE:

 net weight / Nettogewicht / poids net

 volume / Volumen / le volume

 number of packages / Stückzahl der Pakete / nombre de colis