

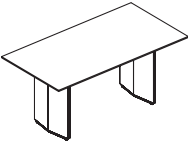

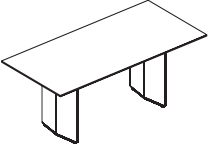

Pace

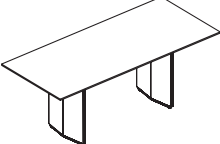
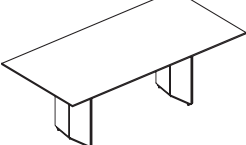
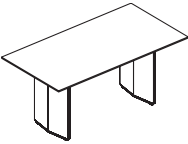
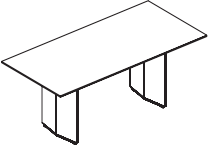
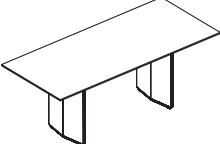
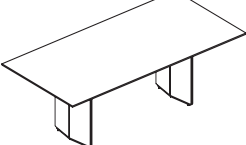
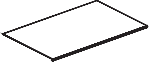
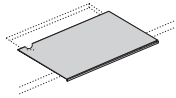

		Dim. in cm W D H	Oak black	Oak light grey titan urban grey mocca Oak matt Oak smoked Cherry Walnut Zebrano	Pear Walnut tobacco Zebrano grey			
	C 07 Table Electrically height-adjustable from 74-114 cm. - Frame lacquer white - Frame lacquer anthracite	200 105	5.863 5.863	5.943 5.943	6.537 6.537			
	C 09 Table Electrically height-adjustable from 74-114 cm. - Frame lacquer white - Frame lacquer anthracite	220 105	5.934 5.934	6.020 6.020	6.674 6.674			
	C 11 Table Electrically height-adjustable from 74-114 cm. - Frame lacquer white - Frame lacquer anthracite	240 105	6.030 6.030	6.121 6.121	6.836 6.836			
	C 21 Meeting table Electrically height-adjustable from 74-114 cm. - Frame lacquer white - Frame lacquer anthracite	258 125	6.415 6.415	6.512 6.512	7.461 7.461			
	C 06 Table - Frame lacquer white - Frame lacquer anthracite	200 105 73	4.120 4.120	4.203 4.203	4.789 4.789			
	C 08 Table - Frame lacquer white - Frame lacquer anthracite	220 105 73	4.206 4.206	4.295 4.295	4.940 4.940			
	C 10 Table - Frame lacquer white - Frame lacquer anthracite	240 105 73	4.317 4.317	4.410 4.410	5.116 5.116			
	C 20 Meeting table - Frame lacquer white - Frame lacquer anthracite	258 125 73	4.616 4.616	4.717 4.717	5.642 5.642			

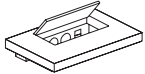
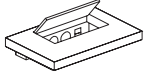
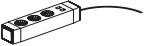
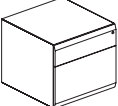
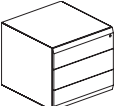
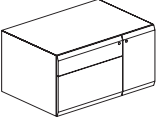
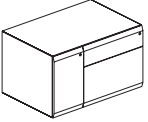
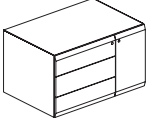
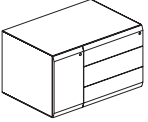
		Dim. in cm W D H	Lacquer white anthracite	Oak black	Oak light grey titan urban grey mocca Oak matt Oak smoked Cherry Walnut Zebrano	Pear Walnut tobacco Zebrano grey		
	C 40	Leather desk pad to C 06 - C 11 Black leather. With edge cover. ... customer-supplied leather Required leather: 120 cm x 93 cm a. 85 x 40 cm	100 63				645	
							528	
	C 41	Sliding leather desk pad to C 06 - C 11 As C 40. Beneath pencil tray, 2 compartments DIN A4, access conduit. C 45 included. Retrofitting or rebuilding impossible. ... customer-supplied leather Required leather: 120 cm x 93 cm a. 85 x 25 cm	100 63				1.871	
							1.754	
	C 42	Cable outlet Chrome, matt chrome or black. Can only be used in conjunction with the electric strip from C 41 / C 43 / C 44 / C 45!	9 9				85	
	C 43	Power box for meeting table The lid is finished to match the tabletop. Access to conduit. C 45 included. Retrofitting or rebuilding impossible.	23 11		1.109	1.109	1.109	
	C 44	Power box for table The lid is finished to match the tabletop. Access to conduit. C 45 included. Retrofitting or rebuilding impossible.	23 11		1.032	1.032	1.032	
	C 45	Power strip 3 sockets, 2 RJ45-sockets. Retrofitting or rebuilding impossible.					563	
	C 63	Container Corpus	60 62,5 55		1.481	1.509	1.868	
	C 63-F	Front panel 1 drawer 1 drawer for printer or filing frame with central locking in front	printer/file drawer: 50 48 28	343				420
	C 64	Container Corpus	60 62,5 55		1.596	1.624	1.984	
	C 64-F	Front panel 3 drawers with central locking in front		447				524

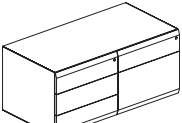
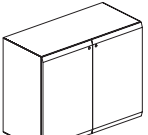
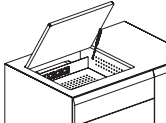
			Dim. in cm W D H	Lacquer white anthracite	Oak black	Oak light grey titan urban grey mocca Oak matt Oak smoked Cherry Walnut Zebrano	Pear Walnut tobacco Zebrano grey		
	C 65	Container Corpus with ventilation	90 62,5 55		1.896	1.926	2.349		
	C 65-F	Front panel 1 drawer, 1 drawer for printer or filing frame, 1 door for PC with locks in front	dimensions printer/file drawer: 50 48 28 dimensions PC compart.: 26 50 48	515 667					
	C 66	Container Corpus with ventilation	90 62,5 55		1.896	1.926	2.349		
	C 66-F	Front panel 1 drawer, 1 drawer for printer or filing frame, 1 door for PC with locks in front	dimensions printer/file drawer: 50 48 28 dimensions PC compart.: 26 50 48	515 667					
	C 67	Container Corpus with ventilation	90 62,5 55		2.015	2.043	2.467		
	C 67-F	Front panel 3 drawers, 1 door for PC with locks in front	dimensions PC compart.: 26 50 48	617 769					
	C 68	Container Corpus with ventilation	90 62,5 55		2.015	2.043	2.467		
	C 68-F	Front panel 3 drawers, 1 door for PC with locks in front	dimensions PC compart.: 26 50 48	617 769					
	C 70	Container Corpus	120 62,5 55		2.447	2.479	2.967		
	C 70-F	Front panel 4 drawers, 1 drawer for printer or filing frame with locks in front	dimensions printer/file drawer: 50 48 28	768 920					
	C 71	Container Corpus	120 62,5 55		2.447	2.479	2.967		
	C 71-F	Front panel 4 drawers, 1 drawer for printer or filing frame with locks in front	dimensions printer/file drawer: 50 48 28	768 920					
	C 80	Highboard Corpus Rear laminate anthracite.	100 47,5 82,5		1.685	1.721	2.142		
	C 80-F	Pair of doors with locks in front		573 735					
	C 92	Lidded compartment for laptop in the container top (C 63-C 71) Position: Only above a drawer. Replaces the top drawer. The flip-up lid is finished to match the corpus of the container. 3 sockets, 2 RJ45-sockets. Contains ventilation grilles in the back panel.	48 42 13 inside dim.		1.112	1.117	1.193		

Product description

PACE

is a management program with high-adjustable desks as well as desks with a set height. Rectangular tabletops rest on a frame with rhombical crosscuts. Containers and a highboard complete the program with their beveled fronts and reflect the formal language of the table panels.

Table tops

The veneered table tops have a MDF core, they are 31 mm thick, the edges are profiled. A 13 mm thick veneer edge merges into a bevel angled 13° toward the bottom. The bevel is lacquered anthracite like the bottom side of the top. Table tops are veneered crossways. Table tops in non-standard sizes are possible on request.

Frame height-adjustable

The frames of all height-adjustable desks offer a range in height from as low as 74 to up to 114 cm. Height adjustment is done electronically. Both panels have a rhombical crosscut and are cased with sheet steel. The panels are available in lacquer white or anthracite. Non-standard colors are possible on request. The horizontal cable conduit and the welt in the groove of the panels are anthracite as standard.

Height-adjustable glides, integrated in the panels, allow the leveling of the table. The cable inlet is carried out either from below or from the side and is preassembled in either the left or right panel following customer requirements.

Frame with a set height

The frame of all desks with a set height is construed for either 73 or 75 cm in height. The easy to open frame elements (on both sides) are set up for interior cabling and can be already equipped in the manufacturing process. Frame measurements and available surfaces comply with the height-adjustable desk version. All further (additional) articles like table runners or electronic accessory can be planned out separately / in the same way.

Tables

The lockable horizontal cable conduit between the panels is accessible from below and allows the setting of the workplace by optional cable outlets or by the sliding leather desk pad.

Meeting table

The open cable channel is also accessible from below and allows the setting of the optional electric boxes or cable outlets.

Security advice: The CE conformity of the height-adjustment as well as the electrification via the frame panels has been verified by DEKRA Stuttgart. Any change of the technical setting and the subsequent laying of cables by a third party may result in damages or accidents. The CE conformity and the liability of the manufacturer lapse due to any change of the product.

Container

Containers consist of a corpus and a front panel.

The corpus is worked on a miter and veneered crossways like the table top. The front panel is available in lacquer white or anthracite, suitable for the table panels, and is chamfered crossways above and below in the identical formal language. The rears are lacquered in the color of the front. Full-extension drawers and doors are opened by „push-to-open“-mechanism.

Leveling feet (Ø 55 mm, black) provide a floor distance of 25 mm.

Cables are routed into the corpus through apertures in the base panel. Containers C 65 – C 68 provide additional ventilation grilles in the rear for technical equipment. We recommend paying careful attention to equipment manufacturers' instructions regarding the ventilation requirements of electronic devices. Printer cables have to be routed in the preinstalled cable brackets.

All containers are available with locking mechanism. The lock cylinders are positioned in the top right corner of the front drawer panel. If doors are hinged on the right, the lock is on the upper left, and vice versa.

Lidded compartment

The container top can be fitted with an integrated compartment for a laptop. The flip-up lid (480 x 413 mm) opens via a hydraulic spring in response to gentle pressure. The compartment must be positioned above the drawer area. It replaces the top drawer completely, although the front panel of the inoperable drawer remains.

The laptop compartment contains a power strip (4 patch fields) with 3 outlets and 2 RJ45-sockets. Ventilation is provided by means of cable apertures in the base panel, openings in the laptop compartment, and two ventilation grilles in the back panel of the container.

Power strips in height-adjustable desks

Without selecting an electric bar height-adjustable tables C 07, C 09, C 11 and C 21 have only one internal wiring for height adjustment, external accessories can not be connected.

The electric strip in table is therefore always separately on the item C 41, C 43, C 44 or to order C 45 and is located in the cable channel running under the tabletop. The power strip is accessible from below via the conduit, with the order of a sliding leather desk pad or a power box it is to be reached from above. The complete wiring for the electric strip is already integrated in the delivery from the factory in the table cheek and may not be retrofitted!

Security advice: Please note that changes or modifications in the cable guide and into the frame of height-adjustable desks cheeks invalidate the CE conformity and carry with it the responsibility of the manufacturer expires.

Power strips in desks with set height

All offered power strips and cable passages are available for desks with a set height. Cabling done by the customer is not limited. Customized solutions / strips can be provided upon request.

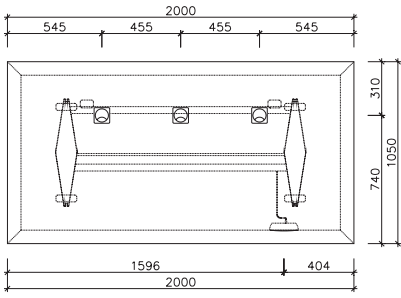

Table C 06 and C 07
C 42 Cable outlet

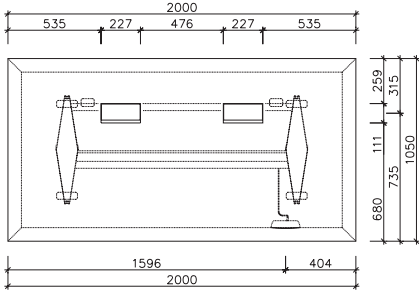

Table C 06 and C 07
C 44 Power box

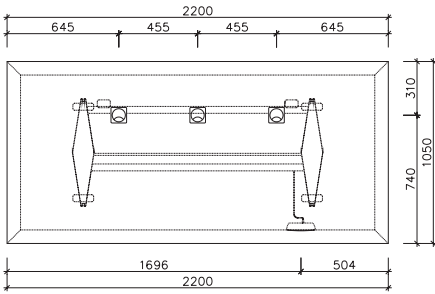

Table C 08 and C 09
C 42 Cable outlet

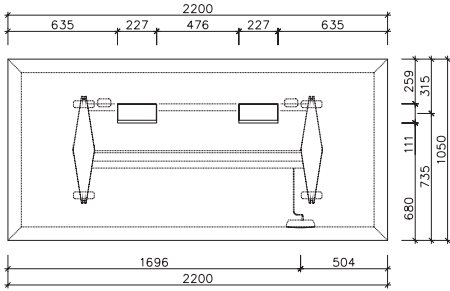

Table C 08 and C 09
C 44 Power box

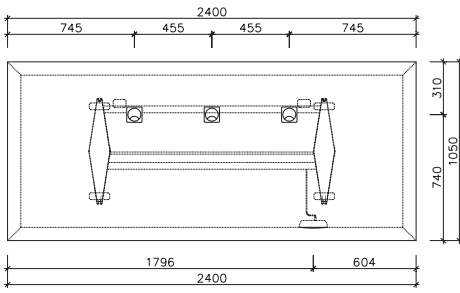

Table C 10 and C 11
C 42 Cable outlet

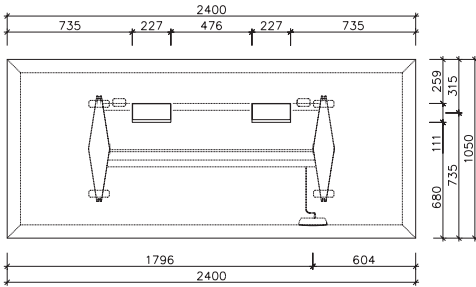
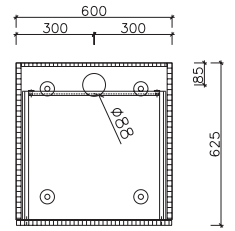
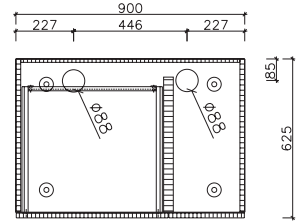

Table C 10 and C 11
C 44 Power box

C 63/C 64 Container



C 65/C 67 Container



C 66/C 68 Container

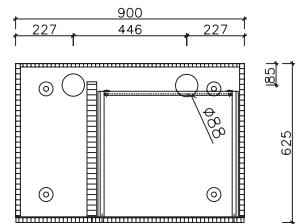

C 70/C 71 Container

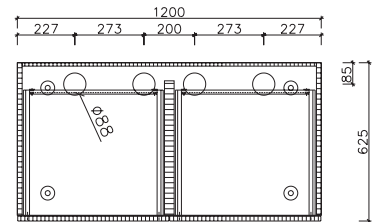

Meeting table C 20 and C 21 / C 42 Cable outlet

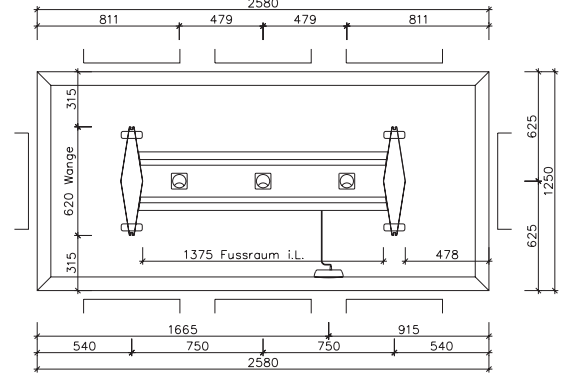

Meeting table C 20 and C 21 / C 43 Power box for meeting table

