

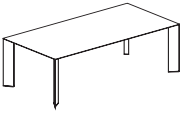

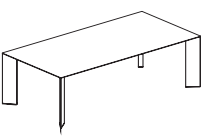

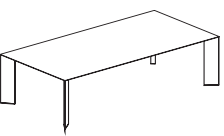

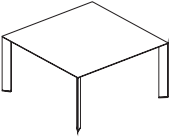
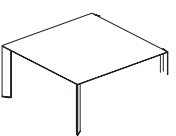
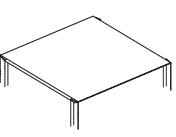
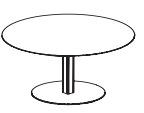
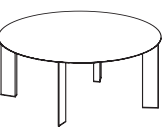
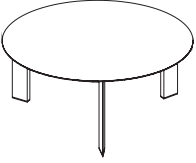

Paper

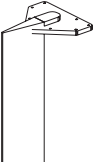
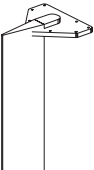

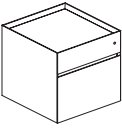
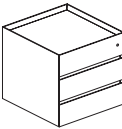
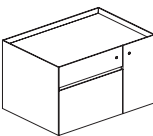
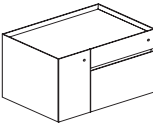
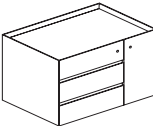
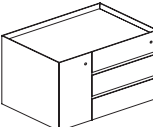
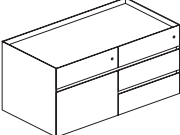
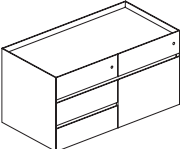
		Dim. in cm W D H	Oak black	Oak light grey titan urban grey mocca Oak matt Oak smoked Cherry Walnut Zebrano	Pear Walnut tobacco Zebrano grey	Lacquer structure white		
	P 05 Desktop In combination with 4 legs P 31	180 90 4	1.663	1.737	2.172	1.683		
	P 07 Desktop In combination with 4 legs P 32 or P 34	200 100 4	1.831	1.911	2.456	1.846		
	P 09 Desktop In combination with 4 legs P 32 or P 34	220 110 4	2.016	2.104	2.769	2.011		
	P 11 Conference top Single top, in combination with 4 legs P 31	155 155 4	2.033	2.120	2.778	2.039		
	P 13 Conference top Start/End top, in combination with P 31. The number of table legs depends on the configuration. Top in combination with P 13 and P 15.	155 155 4	1.980	2.068	2.725	1.985		
	P 15 Conference top Extension top, in combination with P 31. The number of table legs depends on the configuration. Top in combination with P 13 and P 15.	155 155 4	1.848	1.936	2.593	1.855		
	P 21 Meeting table Bottom plate Ø 61 cm, aluminium-coated. - Column white - Column aluminium - Column chromed	Ø 110 73	1.769 1.791 2.014	1.832 1.855 2.078	2.150 2.173 2.396	1.766 1.789 2.011		
	P 23 Meeting top In combination with 4 legs P 31	Ø 125 4	1.598	1.669	2.088	1.611		

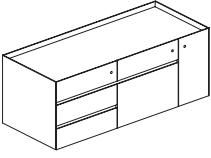
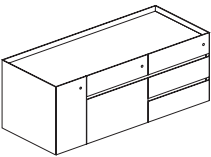
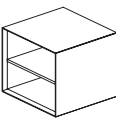
		Dim. in cm W D H	Oak black	Oak light grey titan urban grey mocca Oak matt Oak smoked Cherry Walnut Zebrano	Pear Walnut tobacco Zebrano grey	Lacquer structure white		
	P 25 Meeting tabletop In combination with 3 legs P 32	Ø 158 4	2.004	2.095	2.766	2.005		
	P 31 Table leg width 12 cm Height 73 or 75 cm. - white - aluminium - chromed						245 262 353	
	P 32 Table leg width 16 cm Height 73 or 75 cm. - white - aluminium - chromed						259 280 376	
	P 34 Table leg width 16 cm Height 73 or 75 cm. Veneered surface, the leg is finished to match the tabletop.		697	710	746			
	P 35 Vertical cabling - aluminium - chromed						150 208	
	P 37 Cable tray desktop used for P 05, P 07, P 09						226	
	P 38 Cable tray conference top used for P 11, P 13, P 15						220	
	P 39 Cable tray meeting top used for P 23, P 25						203	

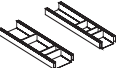
		Dim. in cm W D H	Oak black	Oak light grey titan urban grey mocca Oak matt Oak smoked Cherry Walnut Zebrano	Pear Walnut tobacco Zebrano grey	Lacquer structure white white anthracite aluminium silver		
	P 63	Container Unit with ventilation 1 drawer 1 drawer for printer or filing frame	60 62,5 58				1.550	
	P 63-B	with central locking in front Top panel 60 cm	dimensions printer/file drawer: 50 48 28	270	280	378	1.625 276	
	P 64	Container Unit with ventilation 3 drawers	60 62,5 58				1.832	
	P 64-B	with central locking in front Top panel 60 cm		270	280	378	1.907 276	
	P 65	Container Unit with ventilation 1 drawer, 1 drawer for printer or filing frame, 1 door for PC	90 62,5 58				2.121	
	P 65-B	with locks in front Top panel 90 cm	dimensions printer/file drawer: 50 48 28 dimensions PC compart.: 26 50 48	321	332	485	2.266 327	
	P 66	Container Unit with ventilation 1 drawer, 1 drawer for printer or filing frame, 1 door for PC	90 62,5 58				2.121	
	P 66-B	with locks in front Top panel 90 cm	dimensions printer/file drawer: 50 48 28 dimensions PC compart.: 26 50 48	321	332	485	2.266 327	
	P 67	Container Unit with ventilation 3 drawers, 1 door for PC	90 62,5 58				2.413	
	P 67-B	with locks in front Top panel 90 cm	dimensions PC compart.: 26 50 48	321	332	485	2.562 327	
	P 68	Container Unit with ventilation 3 drawers, 1 door for PC	90 62,5 58				2.413	
	P 68-B	with locks in front Top panel 90 cm	dimensions PC compart.: 26 50 48	321	332	485	2.562 327	
	P 70	Container Unit 4 drawers, 1 drawer for printer or filing frame	120 62,5 58				2.856	
	P 70-B	with locks in front Top panel 120 cm	dimensions printer/file drawer: 50 48 28	375	390	582	3.005 383	
	P 71	Container Unit 4 drawers, 1 drawer for printer or filing frame	120 62,5 58				2.856	
	P 71-B	with locks in front Top panel 120 cm	dimensions printer/file drawer: 50 48 28	375	390	582	3.005 383	

		Dim. in cm W D H	Oak black	Oak light grey titan urban grey mocca Oak matt Oak smoked Cherry Walnut Zebrano	Pear Walnut tobacco Zebrano grey	Lacquer structure white white anthracite aluminium silver		
	P 74 Container Unit with ventilation 4 drawers, 1 drawer for printer or filing frame, 1 door for PC with locks in front	150 62,5 58 dimensions printer/file drawer: 50 48 28 dimension PC compart.: 26 50 48				3.379		
	P 74-B Top panel 150 cm		426	443	679	3.603 434		
	P 75 Container Unit with ventilation 4 drawers, 1 drawer for printer or filing frame, 1 door for PC with locks in front	150 62,5 58 dimensions printer/file drawer: 50 48 28 dimension PC compart.: 26 50 48				3.379		
	P 75-B Top panel 150 cm		426	443	679	3.603 434		
	P 79 Unit open 1 shelf	62,5 62,5 58				1.401		
	P 92 Lidded compartment for laptop Position: Only above a drawer. Replaces the top drawer. The flip-up lid is finished to match the top panel of the container. 3 sockets, 2 RJ45-sockets. Contains ventilation grilles in the back panel.	48 42 13 dim. int.	1.112	1.117	1.193	1.133		
	P 95 Insert with divisions for container, anthracite coloured. To arrange freely.						193	
	P 96 Divider insert for container, aluminium coloured. Max. 2 per drawer.						66	
	P 97 Filing frame for drawer of container P 63, P 65, P 66, P 70, P 71, P 74, P 75						107	

Product description

Paper is a modular system of desks, meeting and conference tables with tabletops in different geometrical shapes. Both, table tops and legs are available in different sizes. Functional containers of matching design complete the offer and provide the practical storage space in the workplace.

Tops

The table tops are manufactured with an MDF core. Cross-veneered table tops are 39 mm thick while white structure lacquer tops are 38 mm thick. The fine and visible outside edges of the table legs are of the same thickness as the edge of the table top. Both measure 6 mm, the corners of the table top are cut accordingly to form a smooth transition. The outside veneer edge merges into an also veneered bevel angled 26° towards the center.

Tabletops are standardized in rectangular, square or round shape; other shapes and sizes are available upon request.

Table legs and connection fixtures

The triangle-shaped table legs come in the two different depths - 12 cm / 16 cm - as well as two different heights - 73 / 75 cm - to ensure a harmonious proportion to the selected size of the table top. The table leg heights are permanently assigned to the table top sizes to ensure stability.

The table legs are available in brushed matt anodised, white powder-coated or chromed aluminium. The 16 cm deep leg is also available in wood cross-veneered to match the also cross-veneered table top.

The wood or aluminium table legs are screwed to the top through consoles, as a single table or as a connection of two tops; Due to design they cannot be exchanged afterwards. All table legs come with an adjustable glide to level uneven floors.

Cable management

The form-fitting vertical cable element is routed on the backside of the table leg and is available in brushed matt anodised or chromed aluminium.

Container

Containers consist of a corpus with several drawers and compartments and a covering panel. The covering panel is either in veneer like the table top or in white structure lacquer or lacquered in the color of the corpus. The corpus is available in lacquer white, lacquer anthracite, lacquer aluminium silver or white structure lacquer. Back, sides and front measure 35 mm to the outside from the covering panel. The inwards chamfered handle strips resume the fine width of the edge of table top (6 mm).

Full extension drawers are equipped with a soft self-closing mechanism. Their color is anthracite.

Black, height-adjustable glides, with a clearance of 25 mm to the floor, provide solid stand of the corpus. Spacious cable apertures in the bottom allow individual cable management and assure adequate air inflow as well. Containers with an embedded computer compartment are also equipped with two ventilation grilles in the back panel. We recommend paying careful attention to equipment manufacturers' instructions regarding the ventilation requirements of electronic devices. When using a printer, the printer cables should be clipped into the preinstalled cable brackets.

All containers are available with locking mechanisms. The lock cylinder is positioned in the top right corner of the drawer front. If compartment doors are hinged on the right side, the lock is placed in the upper left corner, and vice versa. All units of one order have identical locks.

Lidded compartment

The container top can be equipped with an embedded laptop compartment. The flip-up lid (480 x 413 mm) opens through a gas pressure spring in response to a gentle push. The compartment must be positioned above the drawer area. It replaces the top drawer completely, although the optic of the (inoperable) drawer remains.

The laptop compartment contains a power strip with three outlets and two RJ45-sockets. Ventilation is provided by means of cable outlets in the base panel, openings in the laptop compartment and two ventilation grilles in the back panel of the container. We recommend paying careful attention to the equipment manufacturers' instructions regarding the ventilation requirements for electronic devices.

As an option units with sliding doors can be fitted with a lock. All elements of one order work with the same key.

Power box

The lid of the power box is set level with the table top and finished in the same wood veneer or structure lacquer as the table surface around. Cables run through a 17 mm wide cut-out.

Power strips

All power strips come with a GST 18 power input and output. The length of the cable is 2,90 m. Cables for connecting two or more power strips, as well as any other kind of outfitting power strips, are available upon request.

Cable Troughs

There are cable troughs for desks and conference tables available. They are made of powder-coated steel.

Wireless charging / Qi charger

Underneath the table top can be integrated a CE-compliant Qi charger. Please check, if your smartphone provider works with Qi charging technology.

Standard position is on the right-hand side of the user. However, other positions are also realisable upon request.

You can further information at www.renz.de.

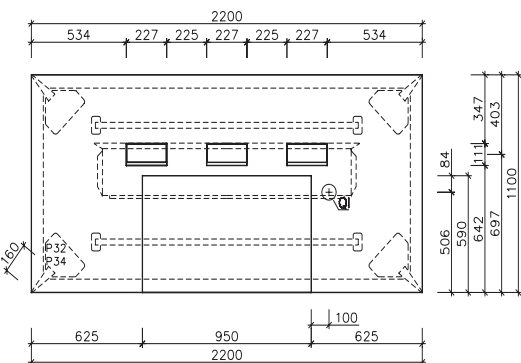
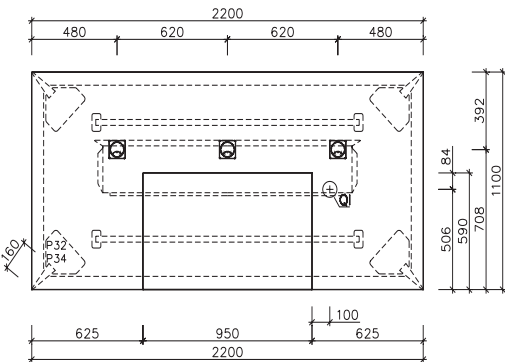
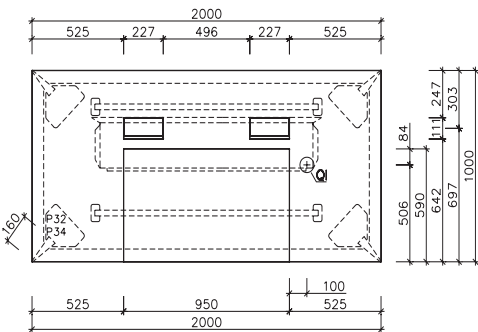
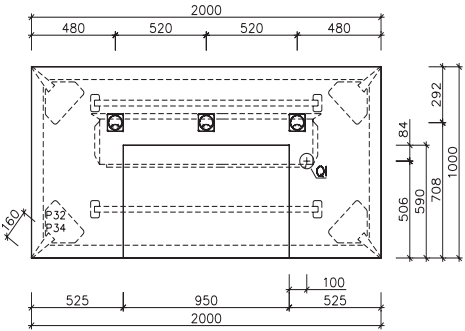
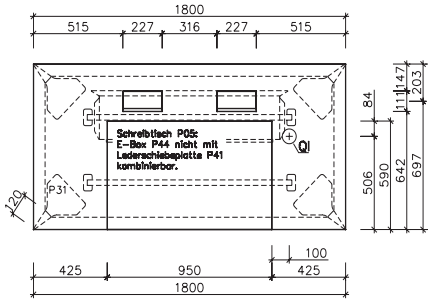
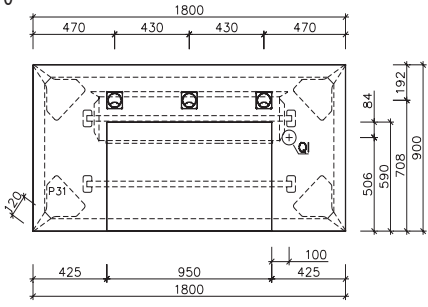

- P 05 Desktop
- P 42 Cable outlet
- P 40 Leather desk pad
- P 41 Sliding leather desk pad

- P 05 Desktop
- P 44 Power box
- P 40 Leather desk pad

- P 07 Desktop
- P 42 Cable outlet
- P 40 Leather desk pad
- P 41 Sliding leather desk pad

- P 07 Desktop
- P 44 Power box
- P 40 Leather desk pad
- P 41 Sliding leather desk pad

- P 09 Desktop
- P 42 Cable outlet
- P 40 Leather desk pad
- P 41 Sliding leather desk pad

- P 09 Desktop
- P 44 Power box
- P 40 Leather desk pad
- P 41 Sliding leather desk pad

- P 11 Konferenztop
- P 44 Elektrobox
- P 38 Cable tray

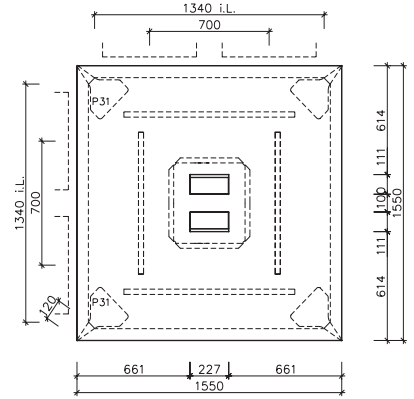

- P 13 and P 15 Conference top
- P 44 Power box
- P 38 Cable tray

