

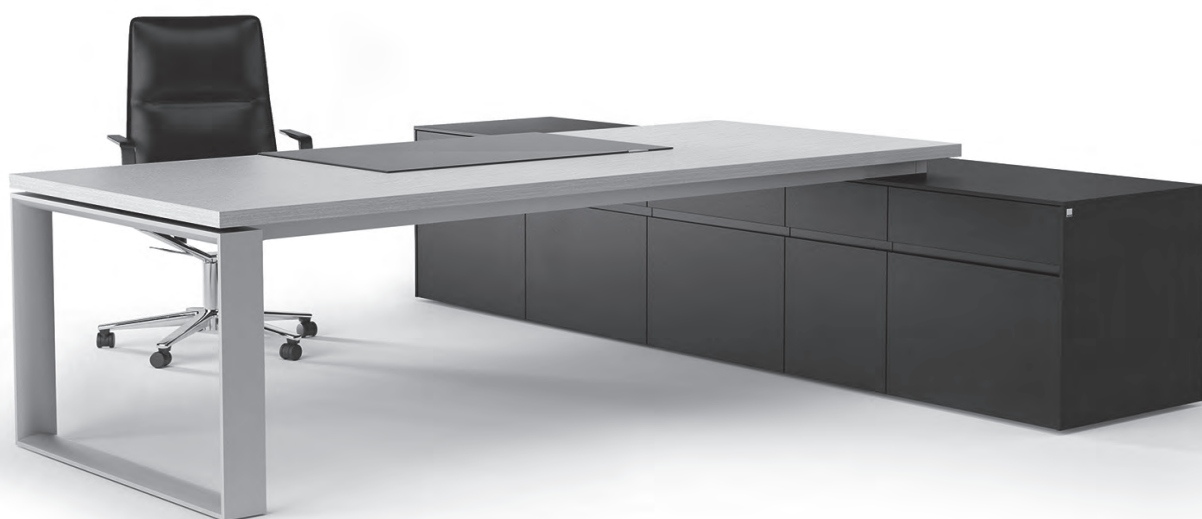

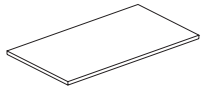

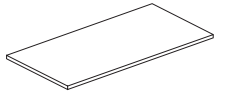

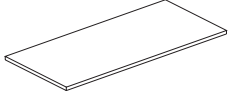

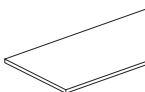
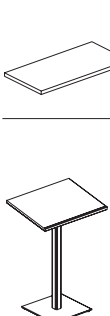
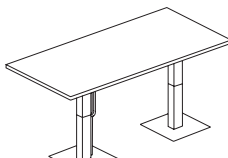
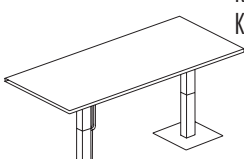

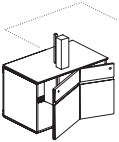
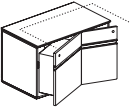
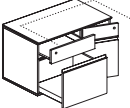













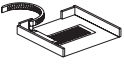

Sono

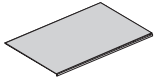
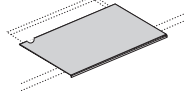
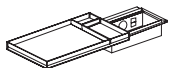

* shown LH	K 05	Top with supporting frame	Dim. in cm W D H	Oak black	Oak light grey titan urban grey mocca Oak matt Oak smoked Cherry Walnut Zebrano	Pear	Walnut tobacco Zebrano grey			
	K 07	Top with supporting frame	200 100 4	1.698	1.819	2.118				
	K 09	Top with supporting frame	220 100 4	1.832	1.957	2.287				
	K 11	Top with supporting frame	240 100 4	1.959	2.094	2.454				
	K 15	Return top to attach to supporting frame	120 60 4	1.007	1.094	1.191				
	K 65	Lectern Column aluminium anodised. Bottom plate 49 x 49 cm, aluminium coloured. Lectern top angled at 10°. With edge strip, aluminium anodised. Height front edge 110 cm.	80 60 110	1.395	1.487	1.660				
	K 22 LH* K 22 RH	Height-adjustable top Columns 10 x 10 cm, aluminium anodised. Bottom plates 50 x 50 cm, aluminium coloured. Electrically height-adjustable from 73-121 cm. Vertical cabling selective lh or rh. Can be supported by container K 39 lh or rh.	220 100 73	5.369	5.492	5.813				
	K 23 LH* K 23 RH	Height-adjustable top Columns 10 x 10 cm, aluminium anodised. Bottom plates 50 x 50 cm, aluminium coloured. Electrically height-adjustable from 73-121 cm. Vertical cabling selective lh or rh. Can be supported by container K 39 lh or rh.	240 100 73	5.494	5.624	5.976				

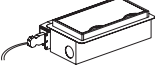
			Dim. in cm W D H	Lacquer silk matt white crema anthracite accent red Lacquer aluminium silver black metallic	Lacquer high gloss white crema anthracite accent red				
	* shown LH								
	K 20	Frame table height 73 cm Aluminium anodised.	11 100			803			
	K 21	Frame table height 75 cm Aluminium anodised.	11 100			803			
	K 39 LH* K 39 RH	Container Encloses one column of the height-adjustable top K 22 and K 23. Vertical cabling via separate channel (aluminium anodised). With ventilation. 1 door for column and PC, 1 door with locks in front	100 60 64 dimensions PC-fitting: 26 50 57	1.535	2.629				
	K 40 LH* K 40 RH	Container to support the desk top With ventilation. 1 door with PC-fitting 1 door with locks in front	100 60 64 dimensions PC-fitting: 48 20 46	2.307	3.429				
	K 41 LH* K 41 RH	Container to support the desk top With ventilation. 1 equipment extension 1 extension for printer or files, 1 door with locks in front	100 60 64 dimensions equip. exten.: 50 48 7 dimensions printer exten.: 50 48 31	2.358	3.476				
	K 42 LH* K 42 RH	Container 1 door, 1 shelf with lock in front	60 60 64	1.138	1.873				
	K 43 LH* K 43 RH	Container as above, with ventilation with lock in front	60 60 64	1.228	1.960				
	K 44 LH* K 44 RH	Container 1 drawer, 1 drawer inside, 1 file extension with lock in front	60 60 64	1.250	1.924				
	K 45 LH* K 45 RH	Container as above, with ventilation with lock in front	60 60 64	1.339	2.011				
	K 46 LH* K 46 RH	Container With ventilation. 1 drawer 1 drawer for printer with lock in front	60 60 64 dimensions printer drawer: 50 48 33	1.704	2.439				
	K 46 LH* K 46 RH	Container With ventilation. 1 drawer 1 drawer for printer with lock in front	60 60 64	1.798	2.528				
	K 46 LH* K 46 RH	Container With ventilation. 1 drawer 1 drawer for printer with lock in front	60 60 64	1.814	2.488				
	K 46 LH* K 46 RH	Container With ventilation. 1 drawer 1 drawer for printer with lock in front	60 60 64	1.904	2.581				
	K 46 LH* K 46 RH	Container With ventilation. 1 drawer 1 drawer for printer with lock in front	60 60 64	1.619	2.294				
	K 46 LH* K 46 RH	Container With ventilation. 1 drawer 1 drawer for printer with lock in front	60 60 64	1.707	2.382				
	K 48 LH* K 48 RH	Container for PC With ventilation. 1 door with lock in front	30 60 64 dimensions PC-fitting: 26 50 57	1.049	1.370				
	K 48 LH* K 48 RH	Container for PC With ventilation. 1 door with lock in front	30 60 64	1.137	1.460				

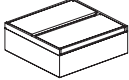
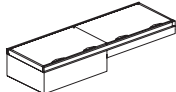
			Dim. in cm W D H	Lacquer silk matt white crema anthracite accent red Lacquer aluminium silver black metallic	Lacquer high gloss white crema anthracite accent red			
* shown LH								
	K 49	End panel to cover the outer side of containers	1,2 60 64	219	443			
	K 86	Power supply For upper drawer of container K 41, K 45 and K 46. Flexible cabling. 3 sockets, 2 RJ45-sockets.		646	646			
	K 60 LH* K 60 RH	Mobile Container 3 drawers with lock in front	62,5 60 58	1.801 1.890	2.792 2.883			
	K 61 LH* K 61 RH	Mobile Container 1 drawer 1 file extension with lock in front	62,5 60 58	1.687 1.773	2.680 2.769			
	K 95	Insert with divisions Aluminium coloured. To arrange freely.		199	199			
	K 96	Divider insert Wire aluminium coloured. Sloping compartments for 6x DIN A4.		121	121			
	K 88	Built-in fridge for container K 43 Fridge 28 litres. Finish black.		1.574	1.574			
	K 73	Leather desk pad for wooden top Black leather. With edge cover. ... customer-supplied leather Required leather: 107 cm x 73 cm	95 53 0,4	619 508	619 508			
	K 75	Sliding leather desk pad As K 73. Beneath pencil tray, 2 compartments DIN A4, power strip K 84 (3 sockets, 2 RJ45-sockets). ... customer-supplied leather Required leather: 118 cm x 102 cm	95 60,5 0,4	1.589 1.480	1.589 1.480			
	K 72	Sliding tray Aluminium anodised. Position see page 34. Containing power strip K 84 (3 sockets, 2 RJ45-sockets).	42 24 3,5	1.083				

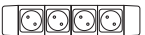
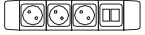
			Dim. in cm W D H					
	K 76	Power box Aluminium anodised. Position see page 34. Containing power strip K 84 (3 sockets, 2 RJ45-sockets).	24 12,5	661				
	K 77	Power box The lid is finished to match the tabletop. Containing a power strip with 3 sockets and 2 RJ45-sockets.	23 11	905				
	K 78	Double power box for meeting tables K 26-K 38 Aluminium anodised. Position: Above or between columns. Containing 2 power strips K 84 (all in all 6 sockets, 4 RJ45-sockets).	24 23	1.134				
	K 79	Toolbox Aluminium anodised. Position see page 34. With utensils tray rh. Containing power strip K 84 (3 sockets, 2 RJ45-sockets).	48 12,5	891				
	K 80	Cable outlet Aluminium lacquered. Ø 8 cm Position see page 34.		123				
	K 81	Vertical cabling Aluminium anodised. To attach to the inner side of frame.		112				
	K 83	Power strip to attach to the cross piece beneath the desk top 4 sockets		112				
	K 84	Power strip to attach to the cross piece beneath the desk 3 sockets 2 RJ45-sockets		368				

Product description

Table tops

Tops are 39 mm thick with an MDF core and edged with thick veneer.

Frame

The frame consists of four sanded and anodised aluminium profiles with mitred assembling. The frames are offered in two heights. An invisible glide levels the unevenness of floors.

Table base

A double aluminium extrusion together with two end frames form the table base. The standard horizontal cable channel is available as well as further accessories, like power strips for the top or the return top. Instead of the second frame, the desk top as well as the return top can rest on a side unit.

Height-adjustable top

This top rests on two electromotive adjustable lifting columns. The desk top can be supported by container K 39 lh or rh.

Meeting tables

There are offered 3 versions of meeting tables:

Circular tables in 110 cm or 125 cm diameter with an aluminium anodised square column of 7,2 x 7,2 cm with a bottom plate 61 cm diameter in aluminium colour finish. Tables are 73 cm high.

Rectangular tables with a fixed column 15 x 15 cm, aluminium anodised and a rectangular bottom plate, aluminium colour finish. The table tops rest on a frame, to which accessories can be fixed. All cabling is carried through the bottom plate and up the column. Tables are 73 cm high.

Rectangular adjustable tables with an anodised column and a rectangular bottom plate. The table tops rest on a frame, to which accessories can be fixed. The table height is continuously electrically operated and adjustable from 73/74 - 121 cm.

Containers

There are 2 versions of containers available: fixed and mobile. The fixed containers are suitable for added use as a side unit. The finish of the containers is lacquer in high gloss, silk matt or metallic. The handle strips are made out of steel. In the finish lacquer black metallic the handle strips are coated in black colour, in all other finishes coated in aluminium colour (RAL 9006). The interior of the containers consists of anthracite colour coated chipboard.

A side unit requires two end panels left hand or right hand (K 49). They are 1,2 cm thick and lacquered in the colour of the front. The covering panel is 1,2 cm thick and is included in the price of the container. The covering panel is in a single section up to a length of 283 cm. The backsides of the containers are lacquered.

Side units used with technical equipment are provided with two grilles for ventilation. We offer these for ventilation as options on drawer and door units. Fixed containers with cable input in the bottom panel and cable output in the side panels with a horizontal wire conduit. The fixed containers have legs which are adjustable inside.

As an option containers can be fitted with a lock in front. The position of it is at the front of the drawer in the upper corner lh or rh. The lock of the rh hinged doors is at the left side and the opposite applies. All elements of one order use the same key.

Electrification of drawer

In the upper drawer (K 86) is a power strip with 3 sockets and 2 RJ 45-sockets. Cables run in a flexible conduit. They may hinder the self-closing runner and the damper of the drawer. For safety reasons and to ensure perfect function the installation on site affords an authorized specialist. Additional arrangements for ventilation have to be checked.

Sliding leather top

Underneath the sliding leather top K 75 is a compartment with a pencil tray, two trays DIN A4, 3 sockets and 2 RJ45-sockets. In addition there is space enough for unused cables and the power supply unit of a laptop. An outlet for cables is situated top left at the sliding leather top.

Sliding tray

The sliding tray K 72 with a A4 case and 2 small cases for utensils can be installed in the table top or the side unit. The tray covers a powerstrip with 3 sockets and 2 RJ45-sockets. Furthermore there is space for unused cables.

Power boxes

There are four versions:

Boxes K 76, K 77 and K 79 can be installed in desk tops and meeting tables. They contain a power strip with 3 sockets and 2 RJ45-sockets.

Box K 79 with a separate cover over a utensil tray. On the reverse side of the cover is a mirror.

Double box K 78 serves only for meeting tables K 26-K 38. It contains two power strips with 6 sockets and 4 RJ45-sockets.

All power strips are fitted with a GST18 power input/output. The length of cable is 2,90 m. If required we supply the cable for connection of two or more power strips. On demand we supply also another version of power strips as f.e. with VGA and audio adapters.

K 40 Container with PC-fitting

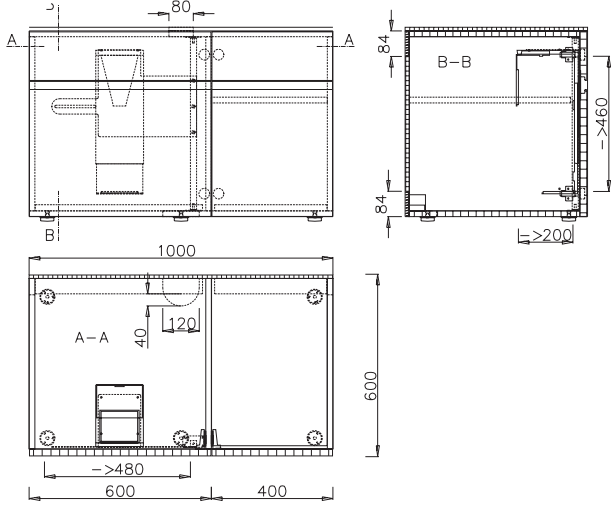

K 48 Container for PC

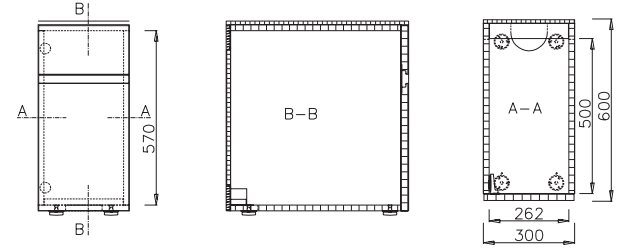

Position advice:
 K 72 Sliding tray
 K 76 / K 77 Power box

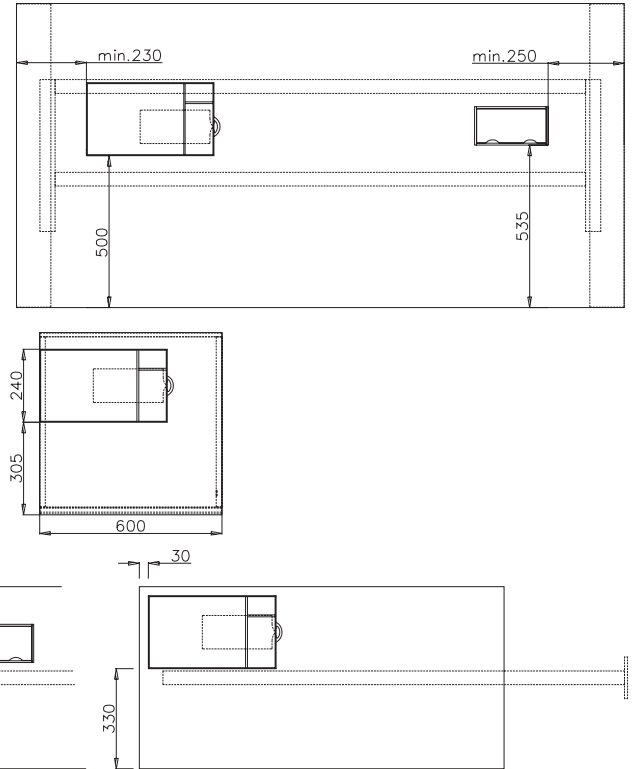

K 41 Container with equipment extension

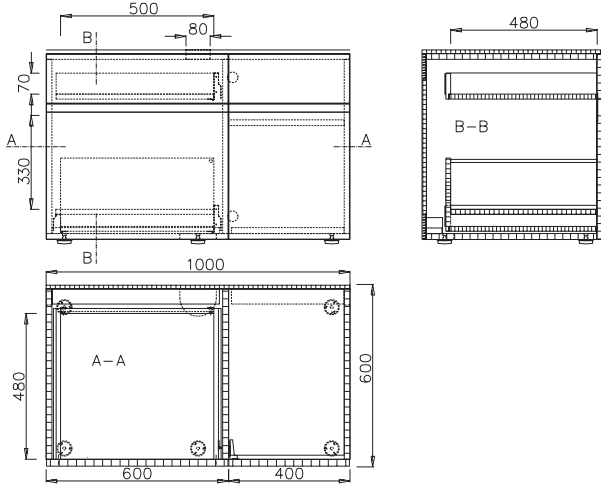

K 46 Container with drawer for printer

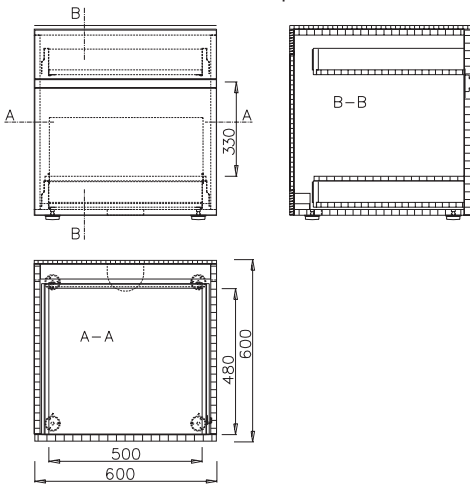

Position advice:
 K 79 Toolbox
 K 80 Cable outlet

