













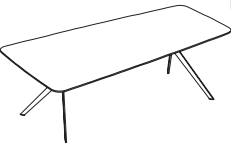



# Star

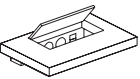

		Dim. in cm W D H	Oak black	Lacquer structure white	Oak light grey titan urban grey mocca Oak matt Oak smoked Cherry Walnut Zebrano	Pear  Walnut tobacco Zebrano grey		
* shown LH								
	R 05 <b>Table</b> - Frame chrome - Frame chrome black - Frame lacquer white or black	180 90 73	2.807 2.900 2.709	2.830 2.923 2.732	2.886 2.979 2.788	3.191 3.283 3.093		
	R 07 <b>Table</b> - Frame chrome - Frame chrome black - Frame lacquer white or black	200 100 73	2.959 3.051 2.857	2.986 3.081 2.886	3.043 3.138 2.943	3.431 3.523 3.330		
	R 09 <b>Table</b> - Frame chrome - Frame chrome black - Frame lacquer white or black	220 100 73	3.040 3.157 2.939	3.073 3.189 2.971	3.133 3.250 3.033	3.561 3.678 3.460		
	R 11 <b>Table</b> - Frame chrome - Frame chrome black - Frame lacquer white or black	240 110 73	3.153 3.269 3.050	3.189 3.306 3.088	3.249 3.365 3.150	3.772 3.888 3.672		
	R 13 <b>Table</b> - Frame chrome - Frame chrome black - Frame lacquer white or black	240 120 73	3.249 3.365 3.150	3.288 3.406 3.188	3.350 3.467 3.249	3.924 4.041 3.823		
	R 15 LH* R 15 RH <b>Table</b> - Frame chrome - Frame chrome black - Frame lacquer white or black	243 127 73	3.316 3.432 3.214	3.357 3.474 3.258	3.420 3.536 3.319	4.037 4.153 3.936		
	R 17 LH* R 17 RH <b>Table</b> - Frame chrome - Frame chrome black - Frame lacquer white or black	246 152 73	4.359 4.517 4.136	4.412 4.570 4.187	4.478 4.636 4.255	5.235 5.392 5.011		

		Dim. in cm W D H	Oak black	Lacquer structure white	Oak light grey titan urban grey mocca Oak matt Oak smoked Cherry Walnut Zebrano	Pear  Walnut tobacco Zebrano grey		
R 21	 <b>Meeting table</b> - Frame chrome - Frame chrome black - Frame lacquer white or black	Ø 110 73	1.747 1.791 1.696	1.764 1.806 1.713	1.814 1.856 1.763	2.037 2.076 1.986		
R 23	 <b>Meeting table</b> - Frame chrome - Frame chrome black - Frame lacquer white or black	240 120 73	3.469 3.586 3.362	3.510 3.627 3.403	3.570 3.686 3.463	4.144 4.261 4.039		
R 25	 <b>Meeting table (two-part)</b> - Frame chrome - Frame chrome black - Frame lacquer white or black	320 127 73	5.457 5.609 5.244	5.514 5.666 5.304	5.643 5.795 5.433	6.414 6.565 6.205		
R 40	 <b>Leather desk pad</b> Black leather  ... customer-supplied leather Required leather: 96 cm x 70 cm	85 55 0,4	540  448	540  448	540  448	540  448		
R 42	 <b>Cable outlet</b> Chrome, matt chrome or black.	9 9	85	85	85	85		
R 43	 <b>Vertical cabling</b> Chrome, chrome black, lacquer white or lacquer black. To attach to a table leg.		130	130	130	130		
R 44	 <b>Power box</b> The lid is finished to match the tabletop. Containing a power strip with 3 sockets and 2 RJ45-sockets.	23 11	905	905	905	905		
R 45	 <b>Power strip</b> 4 sockets		112	112	112	112		

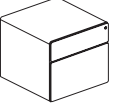
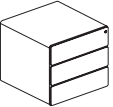
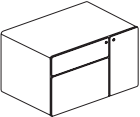
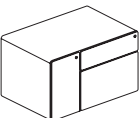
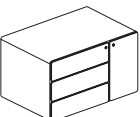
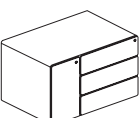
		Dim. in cm W D H	Lacquer aluminium silver black metallic brown metallic structure white	Oak black	Lacquer structure white	Oak light titan grey urban grey mocca Oak matt Oak smoked Cherry Walnut Zebrano	Pear  Walnut tobacco Zebrano grey		
	R 60 <b>Mobile container</b> 3 drawers With central locking device rh. Drawer front is projecting lh or rh and serving as a grip handle.	43 60 55	1.285						
	R 62 <b>Mobile container</b> 1 drawer 1 file drawer With central locking device rh. Drawer front is projecting lh or rh and serving as a grip handle.	43 60 55	1.220						
	R 63 <b>Container</b> Corpus  R 63-F <b>Front panel</b> 1 drawer 1 drawer for printer or filing frame  with central locking in front	60 61,5 55  dimensions printer/file drawer: 50 48 28	1.290	391	397	420	462	467	471
	R 64 <b>Container</b> Corpus  R 64-F <b>Front panel</b> 3 drawers  with central locking in front	60 61,5 55	1.447	521	526	558	593	597	601
	R 65 <b>Container</b> Corpus with ventilation  R 65-F <b>Front panel</b> 1 drawer, 1 drawer for printer or filing frame, 1 door for PC  with locks in front	90 61,5 55  dimensions printer/file drawer: 50 48 28 dimensions PC compart.: 26 50 48	1.631	600	606	643	706	752	759
	R 66 <b>Container</b> Corpus with ventilation  R 66-F <b>Front panel</b> 1 drawer, 1 drawer for printer or filing frame, 1 door for PC  with locks in front	90 61,5 55  dimensions printer/file drawer: 50 48 28 dimensions PC compart.: 26 50 48	1.631	600	606	643	706	752	759
	R 67 <b>Container</b> Corpus with ventilation  R 67-F <b>Front panel</b> 3 drawers, 1 door for PC  with locks in front	90 61,5 55  dimensions PC compart.: 26 50 48	1.788	729	736	783	837	881	887
	R 68 <b>Container</b> Corpus with ventilation  R 68-F <b>Front panel</b> 3 drawers, 1 door for PC  with locks in front	90 61,5 55  dimensions PC compart.: 26 50 48	1.788	729	736	783	837	881	887





## Product description

### STAR

is a modular system for the workplace. Interesting tabletop shapes rest on an organically styled base. Elegant containers and highboards offer storage space as well as all the necessary functions.

### Table tops

The tabletops have an MDF core. Veneered tops are 31 mm thick, white structure lacquer tops are 28 mm thick. Corners are rounded. A 13 mm thick veneer edge merges into a bevel (lacquered MDF) angled 13° toward the center. Tabletops are rectangular or freeform; other shapes and sizes are available upon request.

### Frame

The self-supporting steel frame comes finished in chrome-plated, chrome black, lacquer white or black. Other colors are available upon request. The attachment plate and upper frame are generally coated black. The frame comes in standard table heights of 73 cm and 75 cm. Table legs have black plastic gliders. Horizontal cable management is facilitated by a black metal cable conduit fitted to the upper frame. The vertical cable guide R 43 matches the frame and attaches to the side of it.

### Mobile container

Mobile Containers are offered in lacquer aluminium silver, lacquer black metallic, lacquer brown metallic and lacquer structure white. The 1,5 cm projecting end of the front pieces of the drawers serve a grip handle for opening the drawers and file extensions. The mobile containers are provided with damped self-closing drawers, automatic drawer stop and central locking.

Rh and lh mobile Containers are available. The projecting ends of the drawer front pieces of a rh mobile container are on the left side.

The castors of the containers are partly hidden. Both castors in front are fixable.

### Container

Containers consist of a corpus and a front panel. The corpus is available in lacquer aluminium silver, lacquer black metallic, lacquer brown metallic and lacquer structure white. The transition from the top and base to the side panels is rounded with a 19 mm radius, as are the edges of the front panel, which are finished to match the tabletop.

Doors and full-extension drawers can be opened with a gentle push. Black height-adjustable glides (Ø 55 mm) support the base panel with 25 mm clearance.

Generous cable apertures in the base panel also assure adequate air inflow. Containers with a computer compartment are also fitted with two ventilation grilles in the back panel. We recommend paying careful attention to equipment manufacturers' instructions regarding the ventilation requirements of electronic devices.

The deep drawers can also accommodate a printer. Printer cables should be clipped into the preinstalled cable brackets.

All containers are available with locking mechanism. The lock cylinder is positioned in the top right corner of the front drawer panel. If doors are hinged on the right, the lock is on the upper left, and vice versa. All units supplied in one order are fitted with identical locks.

### Lidded compartment

The container top can be fitted with an integrated compartment for a laptop. The flip-up lid (480 x 413 mm) opens via a hydraulic spring in response to gentle pressure.

The compartment must be positioned above the drawer area. It replaces the top drawer completely, although the front panel of the inoperable drawer remains.

The laptop compartment contains a power strip with three outlets and two RJ45-sockets. Ventilation is provided by means of cable pertures in the base panel, openings in the laptop compartment, and two ventilation grilles in the back panel of the container. We recommend paying careful attention to equipment manufacturers' instructions regarding the ventilation requirements of electronic devices.

### Power box

The lid of the power box is set flush with the tabletop and finished in the same wood veneer or in structure lacquer. A 17 mm cutout accommodates cables.

### Power strips

All power strips come fitted with a GST18 power input/output. The length of cable is 2,90 m. Cables for connecting two or more power strips, as well as other options for outfitting power strips, are available upon request.

The power strip R 45 is designed to be installed to the upper frame or in a container.

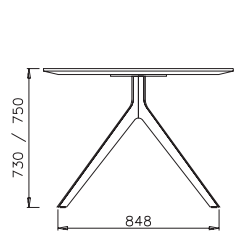
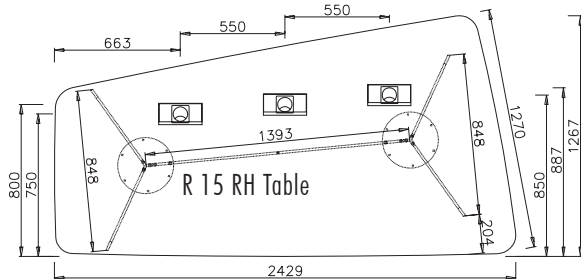
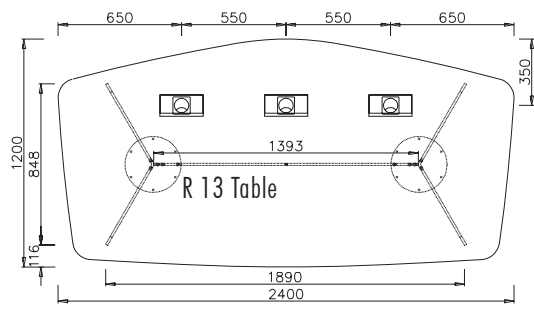
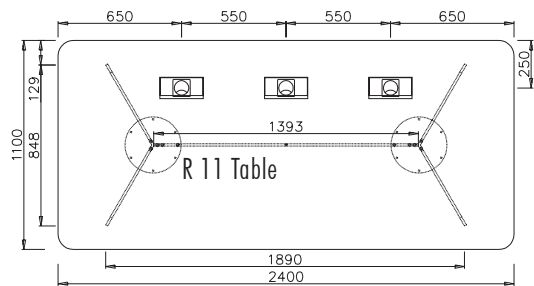
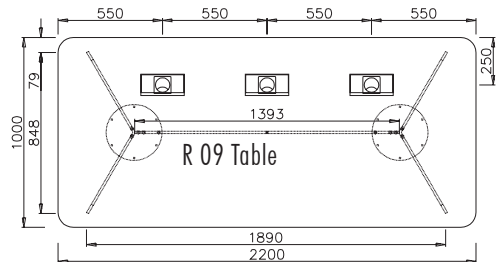
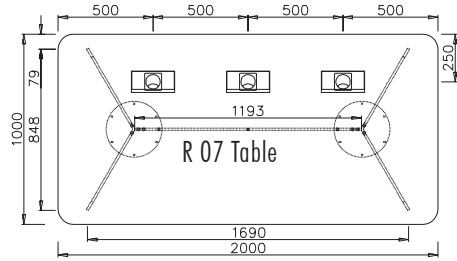
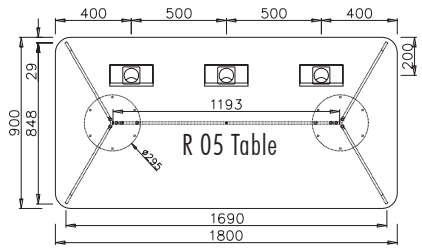

R 07 Side view

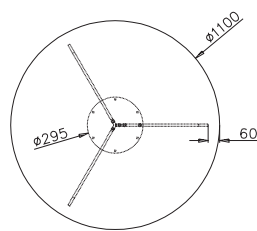

R 21 Meeting table

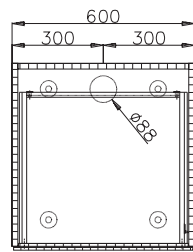
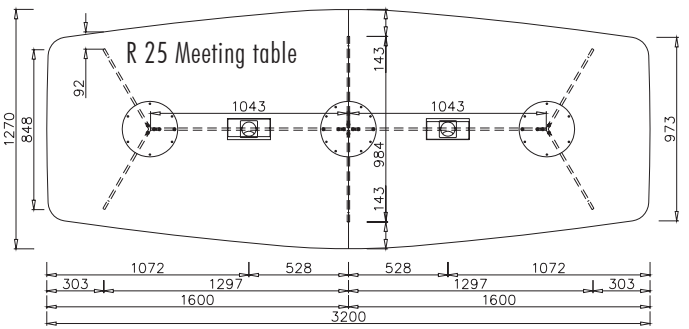
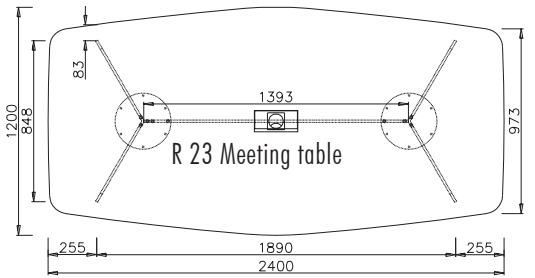
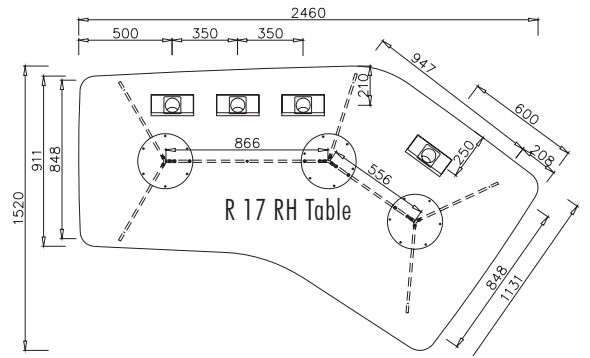

R 63/R 64 Container

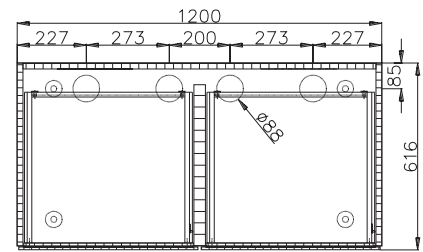

R 70/R 71 Container

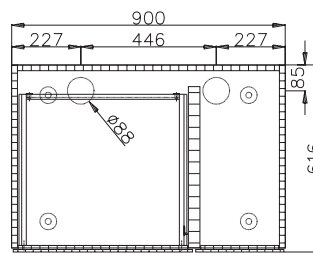

R 65-R 68 Container

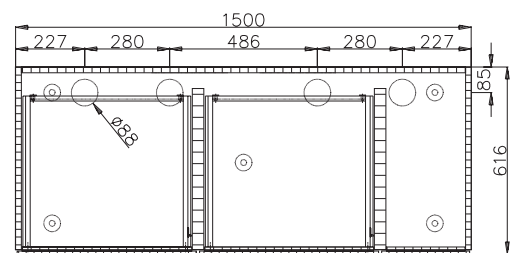

R 74/R 75 Container