

# Talk





**Talk** (Design: Jehs + Laub)

Talk öffnet neue Perspektiven. Ein intelligentes Tischsystem für flexible sowie für feststehende Konferenzen, für Tagungen, Besprechungen und Seminare. Kurz: für alle Kommunikationsbereiche eines Unternehmens. Talk vereint in sich wesentliche funktionale Aspekte. Sein modularer Aufbau gestattet es, unterschiedliche Plattengrößen und -formen miteinander zu kombinieren. Von Einzeltischen bis hin zu ovalen, runden und rechteckigen Tischanlagen. Doch lohnt bei Talk auch der Blick unter die Tischplatte: Der verchromte, leicht und elegant gestaltete Aluminiumfuß garantiert nicht nur Stabilität und maximale Beinfreiheit, bei Tischanlagen übernimmt er auch die Aufgabe als patentes Verbindungselement zwischen zwei Platten. Zwei formschöne Hebel arretieren die Tischbeine an der Platte. Die einfache und schnelle Montage und Demontage erfolgt werkzeuglos. Zur Kabelführung dienen horizontale Kanäle. Vertikale Kabelabdeckungen können an jedem Tischbein nachträglich aufgesteckt werden.

**Talk** (Design: Jehs + Laub)

Talk opens up new prospects. An intelligent table system for both flexible and fixed arrangements for conferences, meetings, and seminars. In short, for all a company's communication needs. Talk integrates key functional features. The modular construction makes it easy to combine different table sizes and forms, from single tables to oval, round and rectangular arrangements. But Talk makes it worth taking a look under the table, too. The light and elegantly designed chrome-plated aluminium base not only guarantees stability and maximum legroom, but also serves to ingeniously connect adjoining tabletops. Two levers discreetly lock the legs to the tabletop. Assembling and disassembling the units is quick and easy, and no tools are required. Horizontal channels accommodate cables. All table legs can be retrofitted with vertical cable covers.



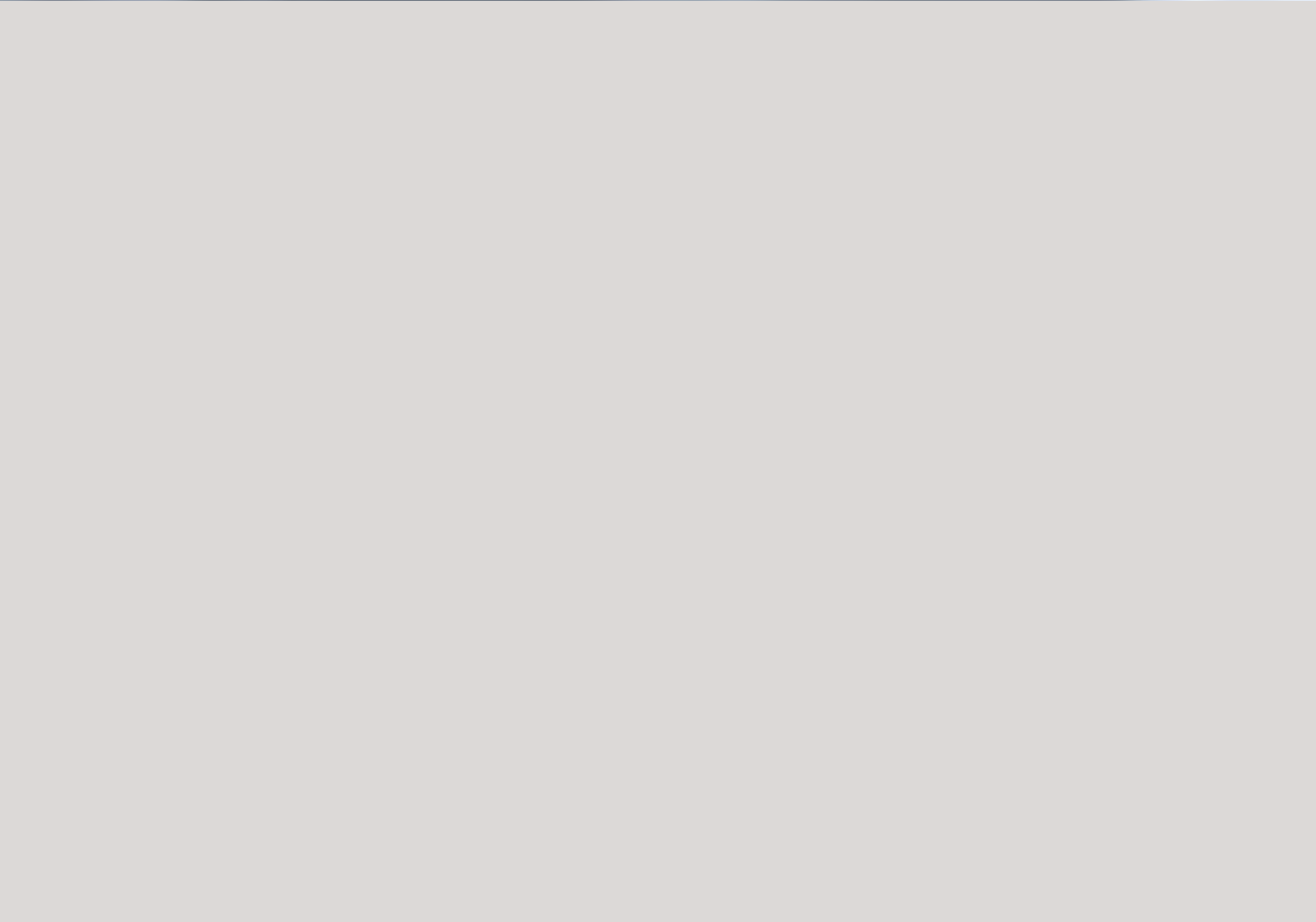

Rechteckige Tischplatten. Rectangle table tops.



160 x 85  
Höhe height 73



220 x 85  
Höhe height 73



180 x 85  
Höhe height 73



240 x 85  
Höhe height 73

Abschlussplatten. End tops.

Viertelkreis Tischplatten. Quarter circle table tops.

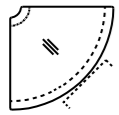

Radius 95 x 85  
Höhe height 73

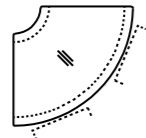

Radius 110 x 85  
Höhe height 73

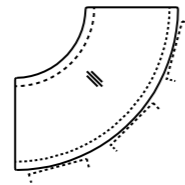

Radius 150 x 85  
Höhe height 73

Eckplatten. Corner tops.

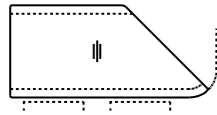

190 x 85  
Höhe height 73



250 x 85  
Höhe height 73

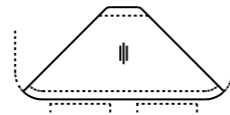

200 x 85  
Höhe height 73

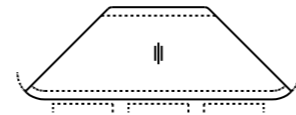

260 x 85  
Höhe height 73

Kopfplatten. Head tops.

Tischfuß. Table leg.

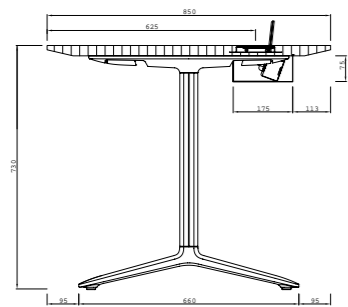

Vertikale Kabelführung. Vertical cabling element.

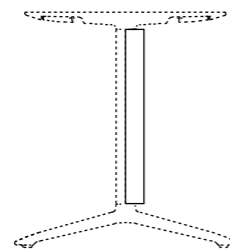

Beispielhafte Konferenztischkonfigurationen. Exemplary conference table configurations.

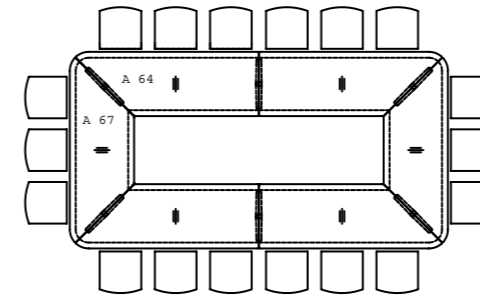

500 x 260  
Höhe height 73

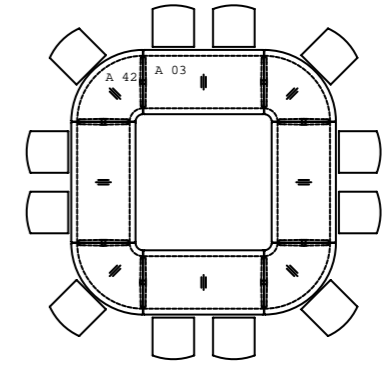

350 x 350  
Höhe height 73

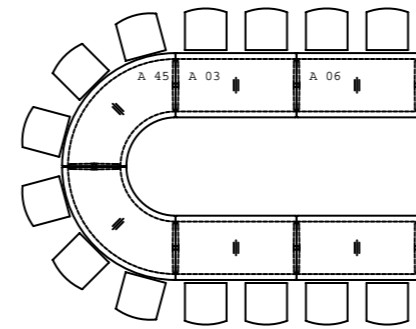

490 x 300  
Höhe height 73

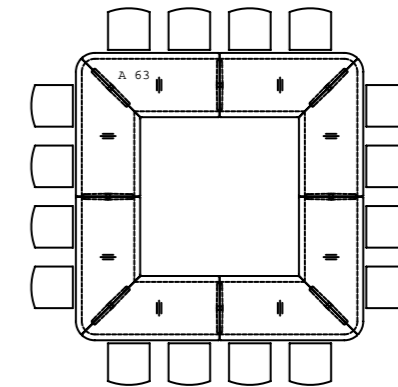

380 x 380  
Höhe height 73

Transportwagen. Transport trolley.

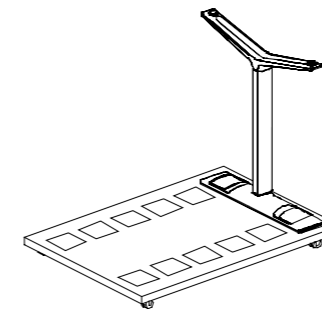

für max. 6 Tischfüße  
for max. 6 table legs

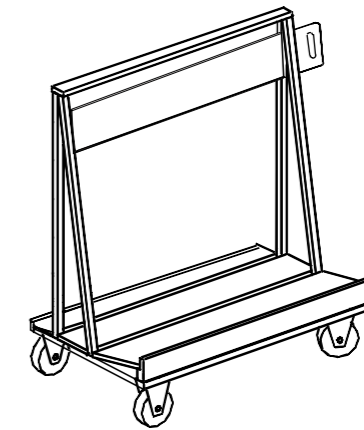

für max. 6 Tischplatten und Kabelkanäle  
for max. 6 table tops and cable conduits

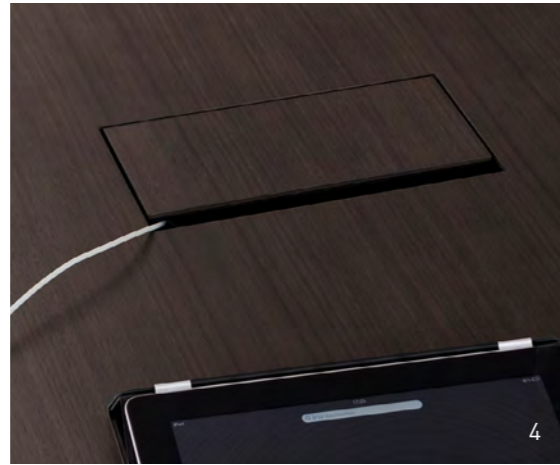

1. Der verchromte Aluminiumfuß kann plattenverbindend positioniert werden.
  2. Die Sichtblende.
  - 3./6. Die Befestigung des Fußes an der Platte erfolgt über 2 Hebel, die werkzeuglos bedient werden.
  4. Elektrobox mit einem Deckel in der Oberfläche der Tischplatte.
  5. Die großvolumigen Kabelkanäle sind abklappbar und können werkzeuglos montiert werden. Die verchromte vertikale Kabelführung kann an jedem Tischfuß aufgesteckt werden.
- 
1. The chrome-plated aluminium frame can be located under the join between two table tops.
  2. The modesty panel.
  - 3./6. The frame is fastening to the table top by means of 2 levers without the need for tools.
  4. Power box with a lid in the same finish as the table top.
  5. The spacious cable conduits are retractable and can be mounted without the need of tools. The chrome-plated vertical cabling element can be fastened to any of the table legs.

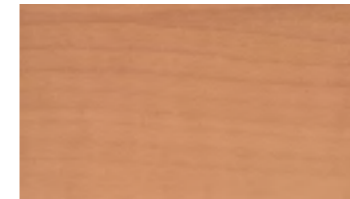

Birnbaum natur  
Pear natural

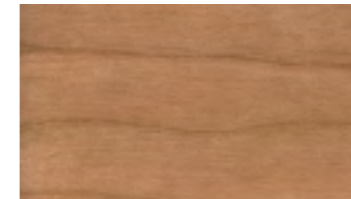

Am. Kirschbaum natur  
Am. Cherry natural



Eiche matt  
Oak matt



Eiche hell  
Oak light

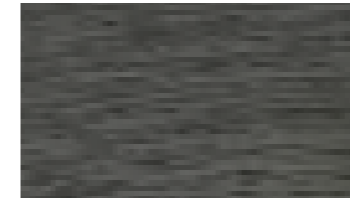

Eiche urban grey  
Oak urban grey



Räuchereiche  
Smoked Oak



Eiche titangrau  
Oak grey titan



Eiche mocca  
Oak mocca

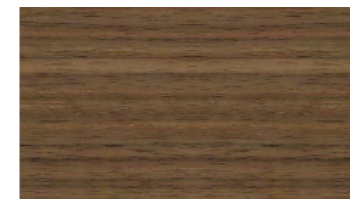

Am. Nussbaum natur  
Am. Walnut natural

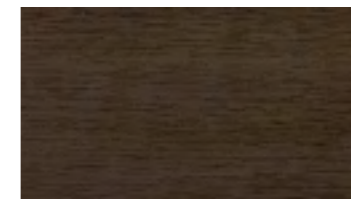

Nussbaum tabac  
Walnut tobacco



Zebrano natur  
Zebrano natural



Zebrano grau  
Zebrano grey



Eiche schwarz  
Oak black

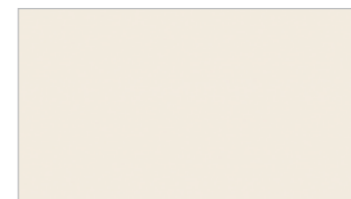

Laminat Nano weiß  
Laminate nano white

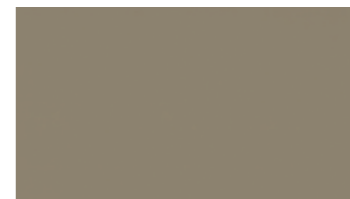

Laminat Nano kitt  
Laminate nano kitt



Laminat Nano schwarz  
Laminate nano black

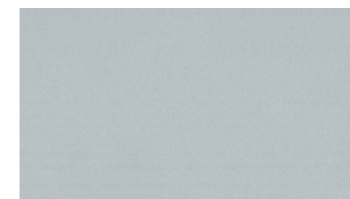

Laminat grau  
Laminate grey

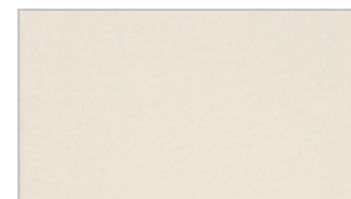

Lack Struktur weiß  
Lacquer structure white

Die abgebildeten Farben sind nicht farbverbindlich. Die Darstellung kann je nach Monitor und Drucker variieren. Weitere Oberflächenausführungen wie Furniere, Laminat und Linoleum nach Muster auf Anfrage. The colours shown are intended as a guideline only. Their representation may vary depending on the monitor and printer. Further surface finishes such as natural wood veneer, laminate and linoleum on request by sample.

Wilhelm Renz GmbH + Co. KG  
Hanns-Klemm-Straße 35  
71034 Böblingen  
Germany

T +49 (0)7031.21880  
F +49 (0)7031.218850

[info@renz.de](mailto:info@renz.de)  
[www.renz.de](http://www.renz.de)